



U.S. DEPARTMENT OF
ENERGY

Prepared for the U.S. Department of Energy
under Contract DE-AC05-76RL01830

PNNL-18597
WTP-RPT-200, Rev 0

PEP Support: Laboratory Scale Leaching and Permeate Stability Tests

RL Russell
RA Peterson

DE Rinehart
WC Buchmiller

September 2009



Pacific Northwest
NATIONAL LABORATORY

*Proudly Operated by **Battelle** Since 1965*

DISCLAIMER

This report was prepared as an account of work sponsored by an agency of the United States Government. Neither the United States Government nor any agency thereof, nor Battelle Memorial Institute, nor any of their employees, makes **any warranty, express or implied, or assumes any legal liability or responsibility for the accuracy, completeness, or usefulness of any information, apparatus, product, or process disclosed, or represents that its use would not infringe privately owned rights.** Reference herein to any specific commercial product, process, or service by trade name, trademark, manufacturer, or otherwise does not necessarily constitute or imply its endorsement, recommendation, or favoring by the United States Government or any agency thereof, or Battelle Memorial Institute. The views and opinions of authors expressed herein do not necessarily state or reflect those of the United States Government or any agency thereof.

PACIFIC NORTHWEST NATIONAL LABORATORY
operated by BATTELLE
for the UNITED STATES DEPARTMENT OF ENERGY
under Contract DE-AC05-76RL01830.

Printed in the United States of America

Available to DOE and DOE contractors from the
Office of Scientific and Technical Information,
P.O. Box 62, Oak Ridge, TN 37831-0062;
ph: (865) 576-8401
fax: (865) 576 5728
email: reports@adonis.osti.gov

Available to the public from the National Technical Information Service,
U.S. Department of Commerce, 5285 Port Royal Rd., Springfield, VA 22161
ph: (800) 553-6847
fax: (703) 605-6900
email: orders@nits.fedworld.gov
online ordering: <http://www.ntis.gov/ordering.htm>

PEP Support: Laboratory Scale Leaching and Permeate Stability Tests

RL Russell
RA Peterson

DE Rinehart
WC Buchmiller

September 2009

Test Specification: 24590-PTF-TSP-RT-07-004, Rev 0 and
24590-PTF-TSP-RT-07-001, Rev 2

Test Plan: TP-RPP-WTP-509, Rev 0.5 and TP-WTP-PEP-044, Rev 0.2

Test Exceptions: 24590-WTP-TEF-RT-07-00016,
24590-WTP-TEF-RT-08-00013, 24590-WTP-TEF-RT-08-00014,
24590-WTP-TEF-RT-08-00015, 24590-WTP-TEF-RT-09-0001 Rev. 1,
24590-WTP-TEF-RT-09-00002

R&T focus area: Pretreatment

Test Scoping Statement: None

Pacific Northwest National Laboratory
Richland, Washington 99352

Completeness of Testing

This report describes the results of work and testing specified by Test Specifications, 24590-PTF-TSP-RT-07-001, Rev 2 and 24590-PTF-TSP-RT-07-004, Rev 0, and Test Plans TP-RPP-WTP-509, Rev. 0.5 and TP-WTP-PEP-044, Rev 0.2. The work followed the quality assurance requirements outlined in the Test Specification and Test Plan. The descriptions provided in this report are an accurate account of both the conduct of the work and the data collected. Test plan results are reported. Also reported are any unusual or anomalous occurrences that are different from expected results. The test results and this report has been reviewed and verified.

Approved:

W.E. *Sumner* for GH Beeman
Gordon H. Beeman, Manager
WTP R&T Support Project

9/25/09
Date

Contents

Abbreviations and Acronyms	ix
Testing Summary	xi
Objective.....	xi
Test Exceptions.....	xvi
Results and Performance Against Success Criteria	xvii
Quality Requirements	xviii
R&T Test Conditions.....	xix
Simulant Use	xxiii
Discrepancies and Follow-on Tests	xxiv
1.0 Background.....	1.1
2.0 Quality Assurance.....	2.1
3.0 Experimental Methods.....	3.1
4.0 Model Input Boehmite Testing.....	4.1
5.0 PEP Support Leaching Tests	5.1
6.0 PEP Parallel Leaching Tests.....	6.1
6.1 PEP Functional Test Caustic Leach	6.1
6.2 PEP Test A Caustic Leach	6.11
6.3 PEP Test B Caustic Leach.....	6.20
6.4 PEP Test D Caustic Leach	6.27
6.5 PEP Tests A, B, and D Oxidative Leach Parallel Laboratory Tests.....	6.35
7.0 Precipitation Study Results.....	7.1
8.0 Cr Caustic and Oxidative Leaching Tests	8.1
8.1 Chromium Characterization Leaching	8.1
8.2 Full Matrix Chromium Leaching Tests	8.3
8.3 Chromium Oxide Leaching Tests	8.5
8.4 Chromium Oxidative Leach Investigation Tests.....	8.8
9.0 References	9.1
Appendix A: Boehmite Dissolution Model	A.1
Appendix B: SOW for Chromium Hydroxide Preparation.....	B.1
Appendix C: Make Up of PEP Simulant and Component Composition and a Recipe for CrOOH Slurry (from WPT-RPT-201)	C.1

Figures

1.1.	PEP Simplified Flow Diagram	1.2
3.1.	Schematic Drawing of the Caustic Leaching Test Setup.....	3.2
3.2.	Simulant Leaching Vessel	3.2
3.3.	Simulant Leaching Vessel Stir Assembly	3.3
7.1.	XRD Pattern of Crystals from Test A Wash Step #3 (Sample Bottle # 2341).....	7.4
7.2.	XRD Pattern of Crystals from Test A Wash #29 (Sample Bottle # 2367).....	7.5
7.3.	Air-Dried Crystals from Various Filtered Odd-Numbered Wash Step Permeate Samples	7.6
7.4.	Even-Numbered Wash-Step Permeate Blend Crystals.....	7.7
7.5.	More Even-Numbered Wash-Step Permeate Blend Crystals	7.7
7.6.	Air-Dried Crystals from the Even-Numbered Wash-Step Permeate Mixture	7.8
7.7.	Crystals Forming After Filtration of Even-Numbered Wash-Step Permeate Blend	7.8
7.8.	Air-Dried Crystals from the 1:1 Wash-Step Permeate: Leachate Mixture.....	7.9
7.9.	Crystals in Test A Initial Solids Concentration Permeate	7.10
7.10.	Polarized Light Picture of Sample Bottle #D_00PF1_015_XX_5653_ARC_4 (post-caustic-leach dewater) with a Standard Na ₃ PO ₄ Picture Beside it	7.11
7.11.	Polarized Light Picture of Sample Bottle #D_00PF1_015_XX_5444_ARC_4 (wash 8) with a Standard Na ₃ PO ₄ Picture Under it	7.12
7.12.	Polarized Light Picture of Sample Bottle #D_00PF1_015_XX_5675_ARC_4 (wash 13) with a Standard Na ₃ PO ₄ Picture (on the left) and a Standard Na ₂ C ₂ O ₄ Picture (on the right) Under it.....	7.13
7.13.	Polarized Light Picture of Sample Bottle #D_00PF1_015_XX_5476_ARC_4 (wash 40) with a Standard Na ₃ PO ₄ Picture (on the left) and a Standard Na ₂ C ₂ O ₄ Picture (on the right) Under it.....	7.14
7.14.	Particle Length Distribution of Sample Bottle #D_00PF1_015_XX_5653_ARC_4 (post-caustic-leach dewater).....	7.15
7.15.	Particle Length Distribution of Sample Bottle #D_00PF1_015_XX_5444_ARC_4 (wash 8)	7.15
7.16.	Particle Length Distribution of Sample Bottle #D_00PF1_015_XX_5675_ARC_4 (wash 13)	7.16
7.17.	Particle Length Distribution of Sample Bottle #D_00PF1_015_XX_5476_ARC_4 (wash 40)	7.16

Tables

Table S.1. Test Objectives from TP-RPP-WTP-509, Rev. 0.5	xii
Table S.2. Test Objectives from TP-WTP-PEP-044, Rev. 0.2	xv
Table S.3. Test Exceptions for Test Plan TP-RPP-WTP-509	xvi
Table S.4. Test Exceptions for Test Plan TP-WTP-PEP-044	xvii
Table S.5. Results and Performance Against Success Criteria of TP-RPP-WTP-509, Rev. 0.5	xvii
Table S.6. Results and Performance Against Success Criteria of TP-WTP-PEP-044, Rev. 0.2.....	xviii
Table S.7. R&T Test Conditions for TP-RPP-WTP-509. Rev. 0.5.....	xx
Table S.8. R&T Test Conditions for TP-WTP-PEP-044, Rev. 0.2.....	xxii
1.1. Testing Objectives and Sample Identification Nomenclature	1.3
4.1. Initial Set of Boehmite Model Input Tests	4.1
4.2. Second Set of Boehmite Model Input Tests	4.2
4.3. Dry-Solids Weight of Boehmite from the Model Input Leaching Tests	4.2
4.4. Al Results for Filtrate from the Initial Set of Boehmite Model Input Leaching Tests	4.3
4.5. Na Results for Filtrate from the Initial Set of Boehmite Model Input Leaching Tests	4.4
4.6. Al Results for Filtrate from the Second Set of Boehmite Model Input Leaching Tests.....	4.5
4.7. Na Results for Filtrate from the Second Set of Boehmite Model Input Leaching Tests	4.5
5.1. Test Matrix for the PEP Support Leaching Tests	5.1
5.2. Test Matrix for the PEP Support Leaching Tests #2	5.1
5.3. Results for Solids from the PEP Support Leaching Tests	5.3
5.4. Al Results for Filtrate from the PEP Support Leaching Tests.....	5.3
5.5. Cr Results for Filtrate from the PEP Support Leaching Tests.....	5.4
5.6. Na Results for Filtrate from the PEP Support Leaching Tests	5.4
5.7. Results for Solids from the PEP Support Leaching Tests #2	5.5
5.8. Al Results for Filtrate from the PEP Support Leaching Tests #2.....	5.5
5.9. Na Results for Filtrate from the PEP Support Leaching Tests #2	5.6
6.2. Supernate Al Analysis from PEP Functional Test Caustic Leach.....	6.3
6.3. Supernate Cr Analysis from PEP Functional Test Caustic Leach.....	6.4
6.4. Supernate Na Analysis from PEP Functional Test Caustic Leach	6.4
6.5. Slurry Analysis from PEP Functional Test Caustic Leach Test 1	6.5
6.6. Slurry Analysis from PEP Functional Test Caustic Leach Test 2	6.5
6.7. Slurry Analysis from PEP Functional Test Caustic Leach Test 3	6.6
6.8. Slurry Analysis from PEP Functional Test Caustic Leach Test 4.....	6.6
6.9. Anion Analysis of PL_LAB_CL_1 Supernate	6.7
6.10. Anion Analysis of PL_LAB_CL_2 Supernate	6.7

Tables

6.11. Anion Analysis of PL_LAB_CL_3 Supernate	6.8
6.12. Anion Analysis of PL_LAB_CL_4 Supernate	6.8
6.13. Anion Analysis of Slurry Samples	6.9
6.14. PEP Parallel Functional Test Density.....	6.10
6.15. PEP Parallel Functional Test Physical Properties of Initial Slurries	6.10
6.16. PEP Parallel Functional Test Free OH Concentration.....	6.11
6.17. PEP Parallel Test A Matrix	6.12
6.18. Supernate Al Analysis from PEP Parallel Test A Caustic Leach	6.13
6.19. Supernate Cr Analysis from PEP Parallel Test A Caustic Leach	6.13
6.20. Supernate Na Analysis from PEP Parallel Test A Caustic Leach	6.14
6.21. Slurry Analysis from PEP Parallel Test A Caustic Leach Test 1	6.15
6.22. Slurry Analysis from PEP Parallel Test A Caustic Leach Test 2	6.15
6.23. Anion Analysis of A_LAB_CL_1 Supernate.....	6.16
6.24. Anion Analysis of A_LAB_CL_2 Supernate.....	6.16
6.25. Anion Analysis of Slurry Samples	6.17
6.26. PEP Parallel Test A Free OH Supernate Concentration.....	6.18
6.27. PEP Parallel Test A Slurry Free OH Concentration.....	6.18
6.28. PEP Parallel Test A Physical Properties for Test 1	6.19
6.29. PEP Parallel Test A Physical Properties for Test 2	6.19
6.30. PEP Parallel Test B Matrix.....	6.21
6.31. Supernate Al Analysis from PEP Parallel Test B Caustic Leach	6.21
6.32. Supernate Cr Analysis from PEP Parallel Test B Caustic Leach	6.22
6.33. Supernate Na Analysis from PEP Parallel Test B Caustic Leach	6.22
6.34. Slurry Analysis from PEP Parallel Test B Caustic Leach Test 1	6.23
6.35. Slurry Analysis from PEP Parallel Test B Caustic Leach Test 2	6.23
6.36. Anion Analysis of B_LAB_CL_1 Supernate	6.24
6.37. Anion Analysis of B_LAB_CL_2 Supernate	6.24
6.38. Anion Analysis of Slurry Samples for Test B Caustic Leach	6.25
6.39. PEP Parallel Test B Free OH Concentration	6.26
6.40. PEP Parallel Test B Physical Properties for Test 1	6.26
6.41. PEP Parallel Test B Physical Properties for Test 2	6.27
6.42. PEP Parallel Test D Matrix	6.28
6.43. Supernate Al Analysis from PEP Parallel Test D Caustic Leach	6.29
6.44. Supernate Cr Analysis from PEP Parallel Test D Caustic Leach	6.29

Tables

6.45. Supernate Na Analysis from PEP Parallel Test D Caustic Leach	6.30
6.46. Slurry Analysis from PEP Parallel Test D Caustic Leach Test 1	6.30
6.47. Slurry Analysis from PEP Parallel Test D Caustic Leach Test 2	6.31
6.48. Anion Analysis of D_LAB_CL_1 Supernate	6.31
6.49. Anion Analysis of D_LAB_CL_2 Supernate	6.32
6.50. Anion Analysis of Slurry Samples for Test D Caustic Leach	6.33
6.51. PEP Parallel Test D Free OH Concentration	6.34
6.52. PEP Parallel Test D Physical Properties for Test 1	6.34
6.53. PEP Parallel Test D Physical Properties for Test 2	6.35
6.54. PEP Parallel Oxidative Test Matrix	6.36
6.55. Supernate Al Analysis from PEP Parallel Test Oxidative Leach	6.37
6.56. Supernate Cr Analysis from PEP Parallel Test Oxidative Leach	6.37
6.57. Supernate Na Analysis from PEP Parallel Test Oxidative Leach	6.38
6.58. Anion Analysis of A_LAB_OL_1 Supernate from Oxidative Leach Tests	6.38
6.59. Anion Analysis of B_LAB_OL_2 Supernate from Oxidative Leach Tests	6.38
6.60. Anion Analysis of D_LAB_OL_3 Supernate from Oxidative Leach Tests	6.39
6.61. Anion Analysis of D_LAB_OL_4 Supernate from Oxidative Leach Tests	6.39
6.62. Slurry Analysis from PEP Parallel Oxidative Leach Test A (Test 1)	6.40
6.63. Slurry Analysis from PEP Parallel Oxidative Leach Test B (Test 2)	6.40
6.64. Slurry Analysis from PEP Parallel Oxidative Leach Test D, Excess MnO_4^- (Test 3)	6.41
6.65. Slurry Analysis from PEP Parallel Oxidative Leach Test D, Less MnO_4^- (Test 4)	6.41
6.66. PEP Parallel Oxidative Test Supernate Density	6.42
6.67. PEP Parallel Oxidative Test Slurry Density	6.43
6.68. PEP Parallel Oxidative Test A_LAB_OL_1 Physical Properties	6.44
6.69. PEP Parallel Oxidative Test B LAB_OL_2 Physical Properties	6.44
6.70. PEP Parallel Test D LAB_OL_3 Physical Properties	6.45
6.71. PEP Parallel Oxidative Test D LAB_OL_4 Physical Properties	6.45
7.1. PEP Test A Wash Permeate Samples	7.2
7.2. Weights of Filtered Solids in Odd-Numbered Test A Samples	7.5
7.3. PSD for Sample 5653	7.17
7.4. PSD for Sample 5444	7.19
7.5. PSD for Sample 5675	7.20
7.6. PSD for Sample 5476	7.21
8.1. Chromium Compound Identification	8.2

Tables

8.2.	Amounts of Components Used in Tests	8.2
8.3.	Cr Caustic Leaching Results from the Chromium Characterization Tests	8.2
8.4.	Cr Oxidative Leaching Results from the Chromium Characterization Tests	8.3
8.5.	Chromium Compound Identification for Full Matrix Testing.....	8.3
8.6.	Components Added to the Full Matrix Chromium Leaching Tests	8.4
8.7.	Al Results from the Full Matrix Chromium Caustic Leaching Tests	8.4
8.8.	Cr Results from the Full Matrix Chromium Caustic Leaching Tests	8.4
8.9.	Na Results from the Full Matrix Chromium Caustic Leaching Tests	8.5
8.10.	Cr Results from the Full Matrix Chromium Oxidative Leaching Tests	8.5
8.11.	Chromium Oxide Identification.....	8.5
8.12.	Components Added to the Chromium Oxide Leaching Tests	8.6
8.13.	Al Results from the Chromium Oxide Caustic Leaching Tests	8.6
8.14.	Cr Results from the Chromium Oxide Caustic Leaching Tests	8.6
8.15.	Na Results from the Chromium Oxide Caustic Leaching Tests.....	8.7
8.16.	Al Results from the Chromium Oxide Oxidative Leaching Tests.....	8.7
8.17.	Cr Results from the Chromium Oxide Oxidative Leaching Tests.....	8.7
8.18.	Na Results from the Chromium Oxide Oxidative Leaching Tests	8.7
8.19.	Chromium Investigative Leach Test Compound Identification	8.8
8.20.	Components Added to the Chromium Investigative Leach Tests	8.9
8.21.	Cr Results from the Chromium Investigative Caustic Leach Tests.....	8.9
8.22.	Cr Results from the Chromium Investigative Oxidative Leach Tests.....	8.9

Abbreviations and Acronyms

AFA	anti-foaming agent
APEL	Applied Process Engineering Laboratory
ASME	American Society of Mechanical Engineers
BNI	Bechtel National, Incorporated
CD	Coriolis densitometer
CUF	crossflow ultrafiltration system (also known as cell unit filter)
DI	deionized (water)
DOE	U.S. Department of Energy
EFRT	External Flowsheet Review Team
HLW	high-level waste
IC	ion chromatography
ICP-AES	inductively coupled plasma-atomic emission spectroscopy
ICP-OES	inductively coupled plasma-optical emission spectrometry
LAW	low-activity waste
LCS	laboratory control sample
PEP	Pretreatment Engineering Platform
PLM	polarized light microscopy
PMP	poly-methyl pentene
PNNL	Pacific Northwest National Laboratory
PSD	particle-size distribution
PTF	Pretreatment Facility
QA	quality assurance
QAM	Quality Assurance Manual
QAP	quality assurance program

QARD	Quality Assurance Requirements and Descriptions (document)
QC	quality control
rpm	revolutions per minute
RPP	River Protection Project
R&T	research and technology
SBMS	Standards-Based Management System
SEM	scanning electron microscopy
SOW	statement of work
SWRI	Southwest Research Institute
TC	thermocouple
TRU	transuranic elements
UDS	undissolved solids
UFP	ultrafiltration process
UV-Vis	ultraviolet-visible
WCS	wet centrifuged solids
WTP	Hanford Tank Waste Treatment and Immobilization Plant
XRD	X-ray diffraction

Testing Summary

This report documents results from a variety of activities requested by the Hanford Tank Waste Treatment and Immobilization Plant (WTP). The activities related to caustic leaching, oxidative leaching, permeate precipitation behavior of waste as well as chromium (Cr) leaching are:

- Model Input Boehmite Leaching Tests
- Pretreatment Engineering Platform (PEP) Support Leaching Tests
- PEP Parallel Leaching Tests
- Precipitation Study Results
- Cr Caustic and Oxidative Leaching Tests.

Leaching test activities using the PEP simulant provided input to a boehmite dissolution model and determined the effect of temperature on mass loss during caustic leaching, the reaction rate constant for the boehmite dissolution, and the effect of aeration in enhancing the chromium dissolution during caustic leaching. Other tests were performed in parallel with the PEP tests to support the development of scaling factors for caustic and oxidative leaching. Another study determined if precipitate formed in the wash solution after the caustic leach in the PEP. Finally, the leaching characteristics of different chromium compounds under different conditions were examined to determine the best one to use in further testing.

The results of the leaching tests to support the development of a boehmite dissolution model were completed in accordance with Test Plan TP-RPP-WTP-509, Rev 0.5,^(a) prepared and approved in response to Test Specification 24590-PTF-TSP-RT-07-004, Rev 0^(b) in Sections 4.0, 5.0, and 8.0.

The results of the PEP parallel testing in Sections 6.0 and 7.0 were performed in accordance with Test Plan TP-WTP-PEP-044, Rev 0.2,^(c) prepared and approved in response to Test Specification 24590-WTP-TSP-RT-07-001, Rev 2 (Huckaby 2008).

Objective

The test objectives for the work addressed in TP-RPP-WTP-509, Rev 0.5^(a) are summarized in Table S.1 along with a discussion of how the objectives were met. The test objectives for the work addressed in TP-WTP-PEP-044, Rev 0.2^(b) are summarized in Table S.2 along with a discussion of how the objectives were met.

-
- (a) RC Daniel and RW Shimskey. 2007. "Test Plan for Simulant Testing in Support of Phase I Demonstration of the Ultrafiltration and Leaching Processes in the Integrated Test Facility." TP-RPP-WTP-509, Rev. 0.5, Pacific Northwest National Laboratory, Richland, Washington.
- (b) PS Sundar. 2007. *Simulant Testing in Support of Phase I Demonstration of the Ultrafiltration and Leaching Processes in the Integrated Test Facility*. WTP Project Doc. No. 24590-WTP-TSP-RT-07-004, Rev. 0.
- (c) RL Russell. 2008. "Test Plan for the PEP Parallel Laboratory Testing." TP-WTP-PEP-044, Rev. 0, Pacific Northwest National Laboratory, Richland, Washington.

Table S.1. Test Objectives from TP-RPP-WTP-509, Rev. 0.5

Test Objective	Objective Met? (Y/N)	Discussion
1) Determine the effect of initial aluminate ion concentration on the rate of boehmite leaching in caustic solutions and in the presence of soluble anions in a waste. The anions to be considered are those that are typically present in the Hanford Tank Farm wastes in significant amounts. This includes carbonate, free-hydroxide, nitrate, nitrite, oxalate, phosphate, and sulfate.	NA	This objective was addressed in report WTP-RPT-184, Rev. 1.
2) Determine the sensitivity of the rate of dissolution of boehmite to soluble anions through a limited number of laboratory tests. The anions to be considered are those that are typically present in the Hanford Tank Farm wastes in significant amounts. This includes carbonate, free hydroxide, nitrate, nitrite, oxalate, phosphate, and sulfate.	NA	As of March 20, 2008, Pacific Northwest National Laboratory (PNNL) has been released from this objective by Test Exception 24590-WTP-TEF-RT-07-00016.
3) Determine the effect of scaling the length of the ultrafilter element from 2 ft to 8 ft on the filtrate flux over the expected operating range of the ultrafilter using the Cell Unit Filter.	NA	This objective was addressed in report WTP-RPT-168, Rev. 0.
4) Use an 8-ft-long filter element in the CUF unit to determine the effect of temperature on the filtration of a waste simulant over the range of temperature conditions for the leaching processes.	NA	This objective was addressed in report WTP-RPT-168, Rev. 0.

Table S.1. Test Objectives from TP-RPP-WTP-509, Rev. 0.5

Test Objective	Objective Met? (Y/N)	Discussion
5) Use a 2-ft-long filter element in the CUF unit to evaluate the effect of the fine particle fraction in the ultrafiltration simulant on fouling of the filter element over the range of concentrations of operating solids. The fine particle fraction is defined as those particles with diameters smaller than the 10 th percentile (i.e., the dp10) of the particle-size number distribution.	NA	This objective was addressed in report WTP-RPT-183, Rev. 0.
6) Perform various simulant aging tests to understand the changes that may occur to the simulant in storage and to ensure the adequacy of the simulant for use in the PEP.	NA	This objective was addressed in report WTP-RPT-198, Rev. 0.
7) Perform Cr-simulant leaching tests to establish that the Cr-simulant from the larger batch exhibits similar or better leaching behavior than the initial trial batch during caustic and oxidative leaching operations.	Y	Cr-simulant leaching tests were performed with a caustic leaching test at 100°C for 24 hours, followed by an oxidative leach at room temperature for 6 hours. These results are presented in Section 8.0.
8) Perform leaching tests to determine the mass loss, and aluminum and chromium dissolution rates during caustic leaching under varying temperature processing conditions without aeration in both UFP-1A/B and UFP-2A/B vessels as well as to measure the effect of aeration on chromium leaching in UFP-2A/B.	Y	These tests were performed by placing the PEP simulant containing the required amount of solids into the reaction vessel and adding the needed amount of caustic and Cr slurry. It was then heated to the required temperature and allowed to react. One test was aerated at ~85-mL/min according to the rotometer reading at laboratory conditions. These results are presented in Section 5.0.
9) Perform leaching tests to develop an accurate model for the dissolution of boehmite.	Y	Caustic leaching tests were performed with boehmite under varying conditions of temperature, amount of gibbsite, and boehmite source. From these tests, a model for the dissolution of boehmite was developed and is presented in Appendix A. The caustic leach results used to develop the model are presented in Section 4.0.

Table S.1. Test Objectives from TP-RPP-WTP-509, Rev. 0.5

Test Objective	Objective Met? (Y/N)	Discussion
10) Perform leaching tests to verify the effect of aluminate ions on the performance of the boehmite component B3 during caustic leach at temperatures lower than 100°C and to determine the effect of temperature on the dissolution rate of boehmite component B7.	NA	This objective was addressed in report WTP-RPT-184, Rev. 1.
11) Perform leaching tests to determine the extent of boehmite dissolution one would expect under leaching conditions during the planned testing in PEP.	Y	These tests were performed by blending the PEP simulant components together in different ratios and then leaching them at 80°C to 100°C to determine the amount of boehmite leached under similar PEP operating conditions. These results are presented in Section 5.0.

Table S.2. Test Objectives from TP-WTP-PEP-044, Rev. 0.2

Test Objective	Objective Met? (Y/N)	Discussion
1) Establish scale factors between laboratory process measurements (e.g., leach factors, filter fluxes) and those of the PEP.	NA	This objective was addressed in reports WTP-RPT-186, Rev. 0, WTP-RPT-188, Rev. 0, and WTP-RPT-197, Rev. 0. The laboratory-scale leaching results to support the development of scaling factors are presented in Section 6.0.
2) Maximize the comparability of the laboratory and PEP process measurements and simplify the development of the scaling relationships. Slurry samples will be collected from the PEP at appropriate points during the testing, transported to a laboratory, and subjected to analogous laboratory testing. Filter flux measurements for slurries with low and high solids concentrations, caustic leaching, and oxidative leaching will each be examined in this fashion.	NA	This objective was addressed in reports WTP-RPT-186, Rev. 0, WTP-RPT-188, Rev. 0, and WTP-RPT-197, Rev. 0. The laboratory-scale leaching results to support the development of scaling factors are presented in Section 6.0.
3) Permeate precipitation testing will be performed to evaluate the propensity of the Phase I simulant permeates to precipitate solids.	Y	This objective is addressed in Section 7.0. It was found that the majority of the wash solutions formed precipitates that appeared to be sodium oxalate and sodium phosphate, which were at their solubility limits but not within the range of feed concentrations expected during pretreatment of the actual HLW.
4) Develop an understanding of the post-filtration precipitation phenomenon.	Y	This objective is addressed in Section 7.0. It was found that the precipitates are mainly sodium oxalate and sodium phosphate, which were at their solubility limits but not within the range of feed concentrations expected during pretreatment of the actual HLW.
5) Develop empirical information needed to 1) understand the operating bounds in concentration and temperature to avoid post-filtration precipitation in the caustic leach process solutions, and 2) identify and assess a need for a change to the flowsheet, if required, to improve process operability.	NA	These results will be presented in a report that is yet to be released.

Test Exceptions

Four test exceptions were issued for Test Plan TP-RPP-WTP-509. These test exceptions are summarized in Table S.3 along with a brief description of how each exception impacted existing objectives and the test plan scope.

There were two test exceptions issued for Test Plan TP-WTP-PEP-044. These test exceptions are summarized in Table S.4 along with a brief description of how each exception impacted existing objectives and the test plan scope.

Table S.3. Test Exceptions for Test Plan TP-RPP-WTP-509

List Test Exceptions	Describe Test Exceptions
24590-WTP-TEF-RT-07-00016, Rev. 0 (ICN-TP-RPP-WTP-509_R0.1)	This test exception released PNNL from test Objective 2 (see Table S.1).
24590-WTP-TEF-RT-08-00013, Rev. 0 (ICN-TP-RPP-WTP-509_R0.2)	This test exception did not affect any existing test plan objectives. It added test objectives concerned with 1) aging of the PEP simulants during storage, and 2) leaching of the chromium simulant. These are Objectives 6 and 7 in Table S.1.
24590-WTP-TEF-RT-08-00014, Rev. 0 (ICN-TP-RPP-WTP-509_R0.3 and ICN-TP-RPP-WTP-509_R0.4)	This test exception both affected existing test objectives and added new test objectives. Tests associated with Objective 4 were modified slightly in response to this test exception. Specifically, the temperatures to study the filter performance were changed from 25°C, 45°C, and 65°C to 25°C, 35°C, and 45°C. In addition, a new objective concerned with the influence of temperature and aeration on caustic leaching processes was added to TP-RPP-WTP-509. These are summarized in Objective 8 in Table S.1.
24590-WTP-TEF-RT-08-00015, Rev. 0 (ICN-TP-RPP-WTP-509_R0.5)	This test exception did not affect any existing objectives in TP-RPP-WTP-509. It added three new test objectives concerned with 1) in-depth assessment of the boehmite leaching kinetics in the presence of dissolved aluminate in significant concentration, and 2) the extent of leaching under planned PEP operating conditions. These are summarized in Objectives 9, 10, and 11 in Table S.1.

Table S.4. Test Exceptions for Test Plan TP-WTP-PEP-044

List Test Exceptions	Describe Test Exceptions
24590-WTP-TEF-RT-09-00001, Rev. 1 (ICN-TP-WTP-PEP-044_R0.2)	This test exception did not affect any existing test plan objectives. It added test objectives concerned with 1) understanding the operating bounds in concentration and temperature to avoid post-filtration precipitation in the caustic leach process solutions, and 2) identifying and assessing a need for a change to the flowsheet, if required, to improve process operability. This is Objective 5 in Table S.2.
24590-WTP-TEF-RT-09-00002, Rev. 0 (ICN-TP-WTP-PEP-044_R0.1)	This test exception did not affect any existing test plan objectives. It added test objectives concerned with developing an understanding of the post-filtration precipitation process. This is Objective 4 in Table S.2.

Results and Performance Against Success Criteria

The success criteria described in TP-RPP-WTP-509, Rev. 0.5, which are listed in Table S.5, do not apply to this report. The success criterion described in TP-WTP-PEP-044, Rev 0.2 that this testing will meet is presenting results that allow a scale-up factor from the laboratory to the PEP testing to be generated. The work described in this report supplies the laboratory-scale leaching results for the development of this scale-up factor. None of the other success criteria, which are listed in Table S.6, are met by this report.

Table S.5. Results and Performance Against Success Criteria of TP-RPP-WTP-509, Rev. 0.5

List Success Criteria	Explain How the Tests Did or Did Not Meet the Success Criteria
1. Develop empirical information that allows determination of the effect of initial aluminate ion concentration on the kinetics of boehmite leaching in a waste simulant.	This criterion is addressed in report WTP-RPT-184, Rev. 1.
2. Determine the sensitivity of boehmite leaching to carbonate, free-hydroxide, nitrate, nitrite, oxalate, phosphate, and sulfate anions in a waste-simulant solution.	As of March 20, 2008, PNNL was released from this objective by Test Exception 24590-WTP-TEF-RT-07-00016.
3. Determine the effect of scaling the length of the ultrafilter element from 2 ft to 8 ft on the performance of the filter over the expected process operating range in transmembrane pressure, axial velocity, and ultrafiltration temperature.	This criterion is addressed in report WTP-RPT-168, Rev. 0.
4. Determine the effect of temperature on the filtration flux for the waste simulant over the range of solids concentrations and temperature conditions for the leaching processes.	This criterion is addressed in report WTP-RPT-168, Rev. 0.
5. Determine the effect of fine-particle concentration on the propensity of the waste simulant to foul the ultrafilter element over the range of concentrations of operating solids in the waste simulant.	This criterion is addressed in report WTP-RPT-183, Rev. 0.

Table S.6. Results and Performance Against Success Criteria of TP-WTP-PEP-044, Rev. 0.2

List Success Criteria	Explain How the Tests Did or Did Not Meet the Success Criteria
1) Generate testing results that allow a scale-up factor from the laboratory testing to the PEP testing to be generated.	Test results were generated that were used in generating a scale-up factor from the laboratory testing to the PEP testing. The laboratory testing data are given in Section 5.0, and the scale-up factor to the PEP testing is discussed in reports WTP-RPT-186, Rev. 0 and WTP-RPT-188, Rev. 0, and will be further addressed in WTP-RPT-197, Rev. 0.
2) Determine the mineralogy of the precipitate phase, precipitate composition, and the solution phase saturation composition for the composite samples from demonstration Test A.	This criterion is not addressed in this report and will be addressed in WTP-RPT-205, Rev. 0.
3) Determine the rate at which the anions—phosphate, oxalate, sulfate, silicate, and fluoride—approach equilibrium solution composition (saturation concentration) in post-caustic-leach slurry at 25°C before filtration.	This criterion is not addressed in this report and will be addressed in WTP-RPT-205, Rev. 0.
4) Identify precipitates formed at ambient temperature in the presence of phosphate, oxalate, sulfate, silicate, and fluoride anions in the post-caustic-leachate solution. Also, determine particle-size distribution (PSD), crystal shape and habit (morphology), quantity, and the settling rate of precipitates formed.	This criterion is not addressed in this report and will be addressed in WTP-RPT-205, Rev. 0.
5) Determine the dilution required to redissolve the post-filtration precipitate through incremental dilution of the slurry with water at 25°C.	This criterion is not addressed in this report and will be addressed in WTP-RPT-205, Rev. 0.
6) Determine solution supersaturation in the post-caustic-leach filtrate during the dewatering period, based on the samples collected at discrete times during Test B in the PEP. The supersaturation shall be expressed as both the centrifuged volume fraction and as weight fraction of the slurry sample. Also, determine the temperature at which the precipitate goes into total solution.	This criterion is not addressed in this report and will be addressed in WTP-RPT-205, Rev. 0.
7) Determine the effects of blending during the post-caustic-leach dewatering and wash periods in Test B in the PEP.	This criterion is not addressed in this report and will be addressed in WTP-RPT-205, Rev. 0.

Quality Requirements

The PNNL quality assurance (QA) program is based upon the requirements as defined in the U.S. Department of Energy (DOE) Order 414.1C, *Quality Assurance*, and 10 CFR 830, *Energy/Nuclear Safety*

Management, Subpart A—Quality Assurance Requirements (a.k.a. the Quality Rule). PNNL has chosen to implement the following consensus standards in a graded approach:

- ASME NQA-1-2000, Quality Assurance Requirements for Nuclear Facility Applications, Part 1, *Requirements for Quality Assurance Programs for Nuclear Facilities*.
- ASME NQA-1-2000, Part II, Subpart 2.7, *Quality Assurance Requirements for Computer Software for Nuclear Facility Applications*.
- ASME NQA-1-2000, Part IV, Subpart 4.2, *Graded Approach Application of Quality Assurance Requirements for Research and Development*.

The procedures necessary to implement the requirements are documented through PNNL's Standards-Based Management System (SBMS).

PNNL implements the RPP-WTP quality requirements by performing work in accordance with the *River Protection Project—Hanford Tank Waste Treatment and Immobilization Plant Support Program* (RPP-WTP) Quality Assurance Plan (RPP-WTP-QA-001, QAP). Work was performed to the quality requirements of NQA-1-1989 Part I, *Basic and Supplementary Requirements*, NQA-2a-1990, Part 2.7, and DOE/RW-0333P, Rev 13, *Quality Assurance Requirements and Descriptions* (QARD), as applicable. These quality requirements are implemented through the *River Protection Project—Waste Treatment Plant Support Program (RPP-WTP) Quality Assurance Manual* (RPP-WTP-QA-003, QAM). The requirements of DOE/RW-0333P, Rev 13, *Quality Assurance Requirements and Descriptions* (QARD) and 10 CFR 830, Subpart A, were not required for this work.

The RPP-WTP addresses internal verification and validation activities by conducting an independent technical review of the final data report in accordance with RPP-WTP's procedure QA-RPP-WTP-604. This review procedure is part of PNNL's *RPP-WTP Quality Assurance Manual* (RPP-WTP-QA-003). Following this procedure, a technical review would verify that the reported results are traceable, that inferences and conclusions are soundly based, and the reported work satisfies the objectives.

Key analytes in the laboratory control sample (LCS) were plotted over time to look for anomalies. In general, the plots of concentrations associated with the inductively coupled plasma (ICP) and ion chromatography (IC) analysis of solutions show recovery within limits of 80% to 120%.

Additional equipment that may be used includes a thermometer, clock and balances. The thermometer for monitoring the batch-contact temperature and the timepiece are standard laboratory equipment for use as indicators only. Balances are calibrated annually by a certified contractor, QC Services, Portland, Oregon.

R&T Test Conditions

The research and technology (R&T) test conditions, as defined in the Test Specifications 24590-WTP-TSP-RT-07-004, Rev. 0^(a) associated with the Test Plan TP-RPP-WTP-509, Rev 0.5, and 24590-PTF-TSP-RT-07-001, Rev. 2 (Huckaby 2008) associated with the Test Plan TP-WTP-PEP-044, Rev 0.2, are summarized in Table S.7 and S.8, respectively.

(a) PS Sundar. 2007. *Simulant Testing in Support of Phase I Demonstration of the Ultrafiltration and Leaching Processes in the Integrated Test Facility*. WTP Project Doc. No. 24590-WTP-TSP-RT-07-004, Rev. 0.

Table S.7. R&T Test Conditions for TP-RPP-WTP-509. Rev. 0.5

List R&T Test Conditions	Were Test Conditions Followed?
1) Boehmite Dissolution Tests—Examine the impact of aluminate, hydroxide, and other principal anions on boehmite dissolution kinetics.	Not applicable to this report. Results discussed in WTP-RPT-184.
2) Boehmite Dissolution Tests—Verify the effect of temperature on the dissolution of boehmite component B7 and verify the effect of aluminate ion on the performance of the boehmite component B3 during caustic leach at temperatures lower than 100°C.	Not applicable to this report. Results discussed in WTP-RPT-184.
3) Boehmite Dissolution Tests—Provide greater discrimination on anion impact by performing tests under a greater range of anion concentrations.	Not applicable to current testing. PNNL was released from this requirement by Test Exception 24590-WTP-TEF-RT-07-00016.
4) Filtration Tests—Test a base simulant under identical process conditions with 2-ft and 8-ft filter elements.	Not applicable to this report. Results discussed in WTP-RPT-168.
5) Filtration Tests—Increase the fines loading in filtration test base simulant to evaluate the impact of fouling on filtration performance.	Not applicable to this report. Results discussed in WTP-RPT-183.
6) Filtration Tests—Use an 8-ft filter element to measure the filtration rate as a function of temperature up to 45°C for the base filtration simulant.	Not applicable to this report. Results discussed in WTP-RPT-168. Tests were originally planned to examine temperatures up to 65°C, but test exception 24590-WTP-TEF-RT-08-00014 limited the upper temperature range to 45°C.
7) Aging Tests—Perform in the 250-gal tote and a 1-gal container in the laboratory, a container in a heat-cycled oven, and a baffled 1-gal container that is mixed in the laboratory. Samples are taken throughout the tests and characterized by PSD, settling, rheology, and centrifuged solids content to evaluate the effect of aging on the behavior of the simulant.	Not applicable to this report. Results discussed in WTP-RPT-198.
8) Chromium Simulant Leaching Tests—Perform with both a caustic leach and an oxidative leach to evaluate the leaching performance of the various vendor batches of Cr-simulant.	All four of the vendor Cr-simulants were tested by caustic leaching with NaOH at 100°C for 24 hours and oxidative leaching using 1 M NaMnO ₄ at room temperature for 6 hours. This is described in more detail in Section 8.2 along with the data being presented.
9) PEP Leaching Support Tests—Carry out with the vendor-produced 250-gal batch of the PEP simulant and the vendor-produced CrOOH Test Batch 1 simulant slurry. The tests are directed to determine the mass loss and aluminum and chromium dissolution rates during caustic leaching under varying temperature processing conditions without aeration in both UFP-1A/B and UFP-2A/B vessels as well as to measure the effect of aeration on chromium leaching in UFP-2A/B.	The vendor-produced 250-gallon batch of PEP simulant along with the vendor-produced CrOOH simulant were used for these tests. Five leach tests were conducted at 20-wt% undissolved solids (UDS), and four leach tests were conducted at 5-wt% UDS. One of the 20-wt% samples was aerated at ~85-mL/min during the leaching time and leached at 85°C. One leach test from each UDS concentration was conducted at 100°C, 95°C, 85°C, and 80°C. The vessels were heated over 6 hours to the

Table S.7. R&T Test Conditions for TP-RPP-WTP-509. Rev. 0.5

List R&T Test Conditions	Were Test Conditions Followed?
	leach temperature and held at the leach temperature for 24 hours. Samples were taken at 1, 2, 4, 8, 12, 16, 20, and 24 hours. This is described in more detail in Section 5.0 along with the data being presented.
<p>10) PEP Leaching Support Tests—Perform using a vendor-produced 250-gal batch of the PEP simulant. The tests are directed to measure the extent of boehmite conversion expected under leaching conditions during the planned testing in the PEP.</p>	<p>The first three tests were performed by centrifuging 5-wt% UDS PEP simulant to remove enough supernate to concentrate it to 20-wt% UDS. Then the 20-wt% UDS PEP simulant was placed into the test vessel with the correct amount of deionized (DI) water and NaOH. The fifth test was performed in the same manner as the first three, except it was not centrifuged, and the original 5-wt% UDS PEP simulant was used. The fourth test was performed by placing the original 5-wt% UDS PEP simulant into the test vessel with the correct amount of DI water and NaOH and heating it to 60°C, holding for 8 hours, and then cooling. After the simulant was cooled, it was centrifuged, and supernate was removed to concentrate it to 20-wt% UDS. Then the 20-wt% UDS PEP simulant was placed into the test vessel with the correct amount of DI water and NaOH. The vessels were then heated to the target leach temperature and an initial sample was taken. Samples were also taken at 1, 2, 4, 8, 12, 24, and 30 hours. This is described in more detail in Section 5.0 along with the data being presented.</p>

Table S.8. R&T Test Conditions for TP-WTP-PEP-044, Rev. 0.2

List R&T Test Conditions	Were Test Conditions Followed?
<p>1) A total of four tests are anticipated. Two of these tests will be conducted entirely with a low-solids concentration simulant (approximately 5-wt%), and the others will be conducted as the simulant is increased to a high-solids concentration (target of 20-wt%, which is PEP's dewatered high-solids target) through dewatering. The first low-solids and dewatering test will be performed with as-received simulant as will the first dewater test. The other tests will be performed with leached materials. These conditions are outlined in Table 5.1. These test conditions are identical to those that will be used in PEP testing (using samples pulled from PEP).</p>	<p>Not applicable to this report. It is addressed in reports WTP-RPT-185 and WTP-RPT-203.</p>
<p>2) These caustic leaching tests will be conducted with slurry samples collected from the PEP leaching vessels just before steam heating is initiated in the PEP after the NaOH has been added. A total of four tests is anticipated. Two of these tests will emulate UFP-VSL-T01A/B (UFP-1) caustic leaching conditions, and two tests will emulate UFP-VSL-T02A (UFP-2) conditions. Test conditions will be specified by WTP to match the PEP.</p>	<p>These tests were performed using samples from PEP taken both just before and just after the caustic solution was added. According to instructions from WTP, the specified amount of caustic, DI water and sample was added and leached at the specified temperature for 24 hours after the specified heating time. Samples were taken at 10°C below specified temperature and then 1 and 2 hours after temperature was reached and every 2 hours over the 24-hour period at 98°C for the Functional tests, Tests A and B, and 85°C for Test D. These results are presented in Section 6.0.</p>
<p>3) Stirred-reactor oxidative leaching tests will be conducted with slurry samples collected from UFP-2 in the PEP just before permanganate is added in the PEP. A total of four tests is anticipated, one for each of the four integrated process tests.</p>	<p>These tests were performed using samples from PEP just before the permanganate was to be added. According to instructions from WTP, the specified amount of 1 M NaMnO₄ was added to the specified amount of sample. The samples were then leached at room temperature for 8 hours with a sample taken every hour. These results are presented in Section 6.5.</p>
<p>4) Several permeate samples will be collected throughout the testing from the PEP, maintained for 10 days at room temperature, and then examined for precipitates. Some will be kept separate, and others will be mixed to provide various conditions.</p>	<p>This was performed on PEP Test A post-caustic wash solutions by allowing several samples to sit for 10 days; several other samples were blended and then allowed to sit for 10 days also. All of the samples showed significant precipitation at the end of the 10 days that appeared to be a mixture of oxalate and phosphate. These results are presented in Section 7.0.</p>

Simulant Use

Actual Hanford tank waste cannot be used in the PEP because of safety, cost, and volume concerns. To address the need to demonstrate separation and leaching processes at PEP, PNNL developed a waste simulant that mimics the chemical, leaching, and ultrafiltration behaviors of actual tank waste under Test Plan TP-RPP-WTP-469, Rev. 0. A simulant formulation developed under TP-RPP-WTP-469 was used for simulant tests described in the controlling test plans, TP-RPP-WTP-509 and TP-WTP-PEP-044.

PEP process testing was performed with a nonradioactive aqueous slurry of simulant waste chemicals and solids. The simulant composition and make-up recipe were provided by WTP as documented in *Simulant Recommendation for Phase 1 Testing in the Pretreatment Engineering Platform*.^(a) Aqueous chemical concentrations were within ranges expected for waste feeds to the PTF except for the hydroxide, oxalate and phosphate anions. The hydroxide concentration was near one standard deviation from the average concentration expected in the feeds to the plant. The oxalate and phosphate components were at or near their respective solubility limits. The solids components and blend were selected to obtain targeted solids mass loss (aluminum and chromium leaching and oxalate washing) and treatment time. The simulant was not selected to represent any particular Hanford tank waste type.

The simulant was blended from the components listed below. The basis for selecting the individual components and the comparison to actual waste behavior are provided where applicable in the indicated references.

- Boehmite (for Al) (Russell et al. 2009a)
- Gibbsite (for Al) (Russell et al. 2009b)
- Chromium oxyhydroxide (CrOOH) slurry (Rapko et al. 2007)
- Sodium oxalate
- Filtration simulant (Russell et al. 2009c)
- Supernate.

Because the high-temperature caustic leaching process was found to dissolve significant amounts of the CrOOH solids, a separate chromium solids simulant was prepared and added to the PEP process after post-caustic-leach washing (a non-prototypic addition) in Integrated Tests A and B. In Test D, the chromium solids component of the simulant was added to the feed to demonstrate the PTF permanganate addition strategy.

Simulant was procured from NOAH Technologies Corporation (San Antonio, TX). Samples of each simulant batch were characterized to make certain that chemical and physical property requirements were met. Batches of the simulant were procured as follows:

- A 15-gallon trial batch of the blended simulant for laboratory testing to demonstrate the efficacy of the simulant fabrication procedure.
- A 250-gallon scale-up batch of the blended simulant to demonstrate scale-up of the simulant fabrication procedure to an intermediate scale.

(a) PS Sundar. 2008. *Simulant Recommendation for Phase 1 Testing in the Pretreatment Engineering Platform*. 24590-PTF-RT-08-006, Rev 0, Bechtel National, Inc., Richland, Washington.

- Batches 0, 1, and 2, each nominally 3500 gallons, of blended simulant for the Shakedown/Functional Tests and Integrated Tests A and B. These batches did not contain the CrOOH component.
- Batch 3, nominally 1200 gal, for Integrated Test D. This batch contained the CrOOH solids component.
- The CrOOH solids slurry for the Shakedown/Functional Test and Tests A and B was obtained in two separate batches containing nominally 18 and 36 kg of Cr as CrOOH.

Discrepancies and Follow-on Tests

None.

1.0 Background

Pacific Northwest National Laboratory (PNNL) has been tasked by Bechtel National Inc. (BNI) on the River Protection Project-Hanford Tank Waste Treatment and Immobilization Plant (RPP-WTP) project to perform research and development activities to resolve technical issues identified for the Pretreatment Facility (PTF). The Pretreatment Engineering Platform (PEP) was designed, constructed, and operated as part of a plan to respond to issue M12, “Undemonstrated Leaching Processes,” of the External Flowsheet Review Team (EFRT) issue response plan.^(a) The PEP is a ¹/_{4.5}-scale test platform designed to simulate the WTP pretreatment caustic leaching, oxidative leaching, ultrafiltration solids concentration, and slurry washing processes. The PEP replicates the WTP leaching processes using prototypic equipment and control strategies. A simplified flow diagram of the PEP system is shown in Figure 1.1.

Two operating scenarios are currently being evaluated for the ultrafiltration process (UFP) and leaching operations. The first scenario has caustic leaching performed in the UFP-2 ultrafiltration feed vessels (i.e., vessel UFP-VSL-T02A in the PEP and vessels UFP-VSL-00002A and B in the WTP PTF). The second scenario has caustic leaching conducted in the UFP-1 ultrafiltration feed preparation vessels (i.e., vessels UFP-VSL-T01A and B in the PEP and vessels UFP-VSL-00001A and B in the WTP PTF).

In both scenarios, 19-M sodium hydroxide solution (NaOH, caustic) is added to the waste slurry in the vessels to leach solid aluminum compounds (e.g., gibbsite, boehmite). Caustic addition is followed by a heating step that uses direct injection of steam to accelerate the leach process. Following the caustic leach, the vessel contents are cooled using vessel cooling jackets and/or external heat exchangers. The main difference between the two scenarios is that for leaching in UFP-VSL-T01A and B, the 19-M NaOH is added to unconcentrated waste slurry (3- to 8-wt% solids), while for leaching in UFP-VSL-T02A, the slurry is concentrated to nominally 20-wt% solids using cross-flow ultrafiltration before adding caustic.

The PEP testing program was conducted under Test Plan TP-RPP-WTP-506^(b) using a waste simulant, which was developed in response to Task 5 from the M-12 EFRT issue response plan. The testing included the following tests with simulated Hanford tank waste:

- Shakedown/Functional Testing: Tested process operations (e.g., slurry transfers, steam heating of the vessels and the accumulation of condensate, filter backpulsing, and flushing), process controls (e.g., transmembrane pressure and axial flow velocity in the filter loop), and certain test functions (e.g., in-line slurry sampling accuracy and precision).
- Integrated Test A: Demonstrated integrated processing when caustic leaching (98°C) is performed in UFP-VSL-00001A/B with the Cr simulant component added after the post-caustic-leach washing step.
- Integrated Test B: Demonstrated integrated processing when the caustic leaching (98°C) is performed in UFP-VSL-00002A with the Cr simulant component added after the post-caustic-leach washing step.

(a) SM Barnes and R Voke. 2006. “Issue Response Plan for Implementation of External Flowsheet Review Team (EFRT) Recommendations - M12: Undemonstrated Leaching Process.” 24590-WTP-PL-ENG-06-0024 Rev. 0.

(b) GB Josephson, OP Bredt, JK Young, and DE Kurath. 2008. *Pretreatment Engineering Platform (PEP) Testing (Phase I)*. TP-RPP-WTP-506, Rev. 0.3, Pacific Northwest National Laboratory, Richland, Washington.

- Integrated Test D: Demonstrated integrated processing when the caustic leaching is performed at a lower temperature (85°C) in UFP-VSL-00002A and with the Cr simulant component added to the initial batch of simulant.

Integrated Test C was deleted from the scope of the testing (ICN-TP-RPP-WTP-506_R0.2).

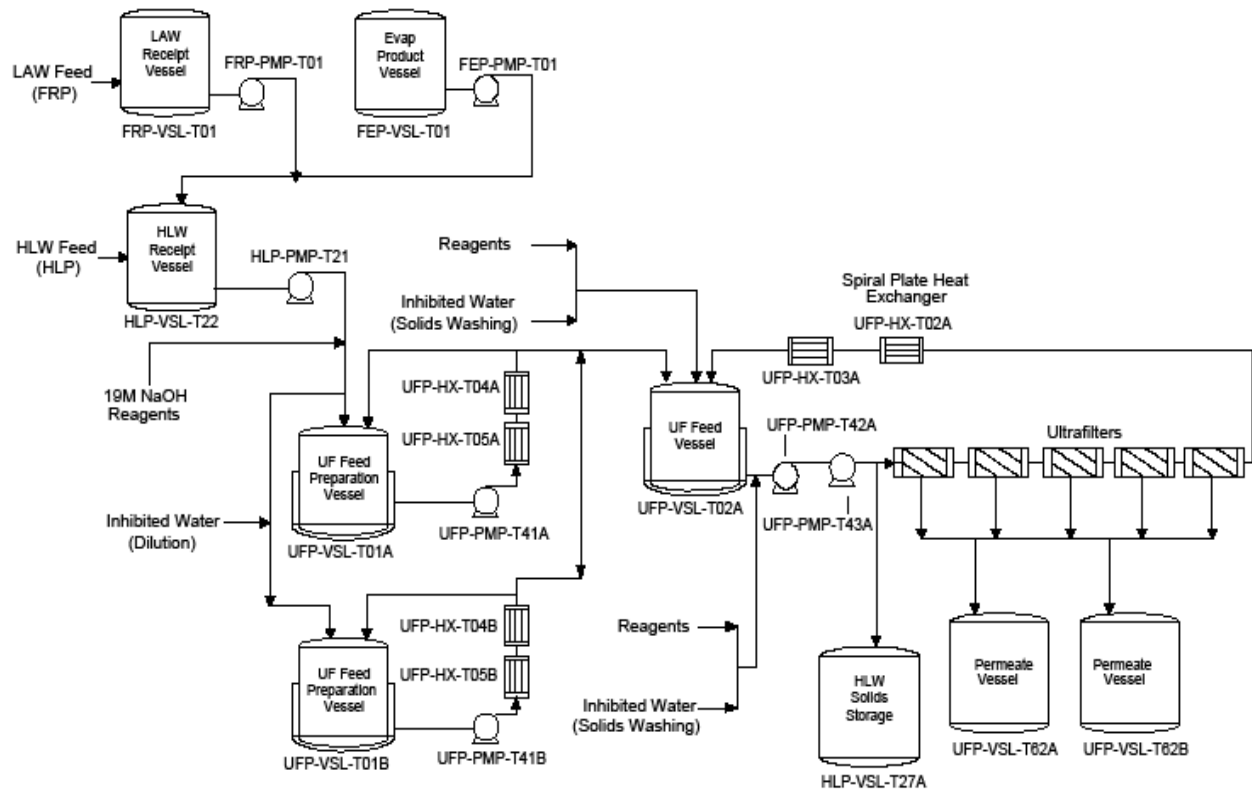

Figure 1.1. PEP Simplified Flow Diagram

Caustic-leaching data are needed on the various types of wastes to be processed through the WTP to support the plant design. The data needed include 1) removal of key HLW sludge components (e.g., Al, Cr, P, and S) as a function of caustic concentration, temperature, and time, 2) the behavior of radionuclides during the leaching process, 3) particle-size distribution (PSD), and 4) identification of the chemical and mineral forms of important sludge components (e.g., Al, Cr, and P) in the sludge solids. These new data will support the development of various waste simulants for scaled process demonstrations.

Aluminum in the wastes is believed to be present in the two most common mineralogical phases: gibbsite (monoclinic $\text{Al}(\text{OH})_3$) and boehmite (orthorhombic AlOOH). Other phases present include bayorite, dawsonite, alumina silicates, and amorphous aluminum hydroxide. The dissolution rates of the two primary mineralogical phases are considerably different. Therefore, the leaching kinetics will depend on the relative amounts of these phases in the waste as well as particle size, crystal habit (i.e., size and shape), operating temperature, hydroxide activity, aluminum solubility limits, particle Reynolds number associated with the mixing system, etc. While there may be other phases of aluminum compounds in the

waste solids, they are present in relatively small amounts and therefore are considered less significant to the caustic leaching for removing aluminum from the high-level waste (HLW).

This report addresses several testing objectives. The experimental methods used in this testing are described in Section 3. The first testing objective provided input to a boehmite dissolution model and is described in Section 4 of this report with the model being described in more detail in Appendix A. The objectives of the next tests were to determine the effect of temperature on the solids mass loss during caustic leaching, the reaction rate constant for the boehmite dissolution, and the effect of aeration in enhancing the chromium dissolution during caustic leaching using the PEP simulant. This is described in Section 5. Section 6 describes the tests that were performed in parallel with the PEP tests to support the development of scaling factors for caustic and oxidative leaching. A study was performed to determine if precipitate formed in the wash solution after the caustic leach in the PEP and is described in Section 7. The final task was to examine the leaching characteristics of different chromium compounds under different conditions to determine the best one to use in further testing. This task is described in Section 8.

Table 1.1 summarizes the testing objectives and sample identification nomenclature covered in this report.

Table 1.1. Testing Objectives and Sample Identification Nomenclature

Section	Test Objectives	Sample Types	Sample Identification Nomenclature
4	Develop boehmite dissolution model as a function of test time.	Filtrate samples from caustic boehmite leaching tests.	B-AL1 to B-AL20. B-AL1a to B-AL10a.
5	Determine the effect of temperature on boehmite leaching coefficient and the effect of aeration on chromium leaching.	Slurry and supernate taken as a function of time and temperature.	PST-1 to PST-9. PST2-1 to PST2-7. INS = initial slurry. FIS = initial washed slurry before heating. FWS = final washed slurry after cooled.
6	Determine scale factors between PEP and laboratory tests		
6.1	Make direct comparison with the PEP Functional Caustic Leach Tests.	Slurry and supernate taken as a function of time and temperature.	PL-1 to PL-4. LAB CL = Lab Caustic Leach. IS_SL = initial washed slurry. FS1 to 3_SL = final washed slurry sample 1 to 3. A_LAB_CL_1_IS_SL, etc. = in Tables 6.5 thru 6.8, and 6.13, A= PL. IN_SL = initial slurry. FS = final washed slurry. SUP = supernate.
6.2	Make laboratory comparisons to PEP Test A Caustic Leach Tests.	Slurry and supernate taken as a function of time and temperature.	A_LAB_CL = PEP Parallel Test A Laboratory Caustic Leach. SL = slurry. ISW = initial washed slurry. IS = initial unwashed slurry. FS1 through FS3 = final washed slurry. FS4 = final unwashed slurry.

6.3	Make laboratory comparisons to PEP Test B Caustic Leach Tests.	Slurry and supernate taken as a function of time and temperature.	B_LAB_CL = PEP Parallel Test B Laboratory Caustic Leach. SL = slurry. ISW = initial washed slurry. IS = initial unwashed slurry. FS1 and FS2 = final washed slurry. FS3 = final unwashed slurry.
6.4	Make laboratory comparisons to PEP Test D Caustic Leach Tests.	Slurry and supernate taken as a function of time and temperature.	D_LAB_CL = PEP Parallel Test D Laboratory Caustic Leach. SL = slurry. ISW = initial washed slurry. IS = initial unwashed slurry. FSW = final washed slurry. FS = final unwashed slurry.
6.5	Make laboratory comparisons to PEP Oxidative Leach Tests.	Slurry and supernate taken as a function of time and temperature.	A_LAB_OL = PEP Parallel Test A Laboratory Oxidative Leach. B_LAB_OL = PEP Parallel Test B Laboratory Oxidative Leach. D_LAB_OL = PEP Parallel Test D Laboratory Oxidative Leach. ORG_SUP = original supernate before MnO_4^- addition. INA_SUP = initial supernate after MnO_4^- addition. SL = slurry. IS = initial slurry after MnO_4^- addition. ISW = initial washed slurry after MnO_4^- addition. OSW = initial washed slurry before MnO_4^- addition. OS = initial slurry before MnO_4^- addition. FWS = final washed slurry. FS = final slurry.
8	Test leaching properties of different chromium compounds under different conditions.	Supernate taken as a function of time and temperature.	CL-C1 to CL-C7, OL-C1 to OL-C7. FMC1 to FMC5, FMO1 to FMO5. CL-CO1 to CL-CO6, OL-CO1 to OL-CO6. CLI1 to CLI5. CL = caustic leach. OL = oxidative leach. FMC = full-matrix caustic leach. FMO = full-matrix oxidative leach.

2.0 Quality Assurance

The PNNL QA program is based upon the requirements as defined in the U.S. Department of Energy (DOE) Order 414.1C, *Quality Assurance*, and 10 CFR 830, *Energy/Nuclear Safety Management*, Subpart A—*Quality Assurance Requirements* (a.k.a. the Quality Rule). PNNL has chosen to implement the following consensus standards in a graded approach:

- ASME NQA-1-2000, Quality Assurance Requirements for Nuclear Facility Applications, Part 1, *Requirements for Quality Assurance Programs for Nuclear Facilities*.
- ASME NQA-1-2000, Part II, Subpart 2.7, *Quality Assurance Requirements for Computer Software for Nuclear Facility Applications*.
- ASME NQA-1-2000, Part IV, Subpart 4.2, *Graded Approach Application of Quality Assurance Requirements for Research and Development*.

The procedures necessary to implement the requirements are documented through PNNL's Standards-Based Management System (SBMS).

PNNL implements the RPP-WTP quality requirements by performing work in accordance with the *River Protection Project—Hanford Tank Waste Treatment and Immobilization Plant Support Program* (RPP-WTP) Quality Assurance Plan (RPP-WTP-QA-001, QAP). Work was performed to the quality requirements of NQA-1-1989 Part I, *Basic and Supplementary Requirements*, NQA-2a-1990, Part 2.7, and DOE/RW-0333P, Rev 13, *Quality Assurance Requirements and Descriptions* (QARD), as applicable. These quality requirements are implemented through the *River Protection Project – Waste Treatment Plant Support Program (RPP-WTP) Quality Assurance Manual* (RPP-WTP-QA-003, QAM). The requirements of DOE/RW-0333P Rev 13, *Quality Assurance Requirements and Descriptions* (QARD) and 10 CFR 830 Subpart A were not required for this work.

The RPP-WTP addresses internal verification and validation activities by conducting an independent technical review of the final data report in accordance with RPP-WTP's procedure QA-RPP-WTP-604. This review procedure is part of PNNL's *RPP-WTP Quality Assurance Manual* (RPP-WTP-QA-003). Following this procedure, a technical review would verify that the reported results are traceable, that inferences and conclusions are soundly based, and the reported work satisfies the objectives.

Key analytes in the laboratory control sample (LCS) were plotted over time to look for anomalies. In general, the plots of concentrations associated with the inductively coupled plasma (ICP) and ion chromatography (IC) analysis of solutions show recovery within limits of 80% to 120%.

Additional equipment that may be used includes a thermometer, clock, and balances. The thermometer for monitoring the batch-contact temperature and the timepiece are standard laboratory equipment for use as indicators only. Balances are calibrated annually by a certified contractor, QC Services, Portland, Oregon.

3.0 Experimental Methods

The caustic leaching tests were set up as shown in Figure 3.1 using 1-wt% solids or PEP slurry in 800 to 900 grams of total solution (solids + liquid) that was heated to the appropriate temperature while stirring in a 1-liter polymethyl pentene (PMP) reaction vessel. The material to be leached is added to the reaction vessel through the sample port while stirring after the leaching solution has reached leaching temperature, which starts the clock for the test when powders are being leached. When slurries are being leached, they are added at the beginning and heated along with the leach solution. The test solution is sampled while stirring at the specified sampling hours. Each supernatant sample consists of 5-mL slurry, which is filtered through a 0.45- μ m syringe filter to produce supernatant.

Five reaction vessel systems were typically run in parallel, allowing five tests to be performed at once. Each reaction vessel is a straight-side wide-mouth jar with an inside height of 116 mm and an inside diameter of 110 mm. It has three PMP baffles, 92 mm long, 5 mm thick, and 19 mm wide, evenly spaced around the vessel. Figure 3.2 shows a picture of the testing vessel. A stainless steel stir shaft (8 mm in diameter and 305 mm long) with a 95 mm wide blade welded on the bottom, is used to stir the vessel contents as shown in Figure 3.3. The blade is 13 mm tall, and each blade has a 45° pitch and pushes the fluid down while stirring. Stirring was consistently performed at 150 rpm for these tests, which provides complete mixing. A heating jacket is wrapped around the vessel to maintain the test mixture at a constant temperature throughout the test. The temperature is measured with a calibrated thermocouple (TC) and controlled with a calibrated temperature controller. Aeration was performed by passing building air through a rotometer and into a metal tube that had been placed near the bottom of the reaction vessel.

All tests were monitored for evaporation by comparing the sodium levels in the tests because the sodium level should not have been changing. When aeration was not performed, the tests were so short and the vessels were so tightly sealed that evaporation was not an issue. However, when aeration was performed, a level in the reaction vessel was maintained by marking the initial solution level and maintaining that by adding deionized water periodically.

Some slurry samples were also analyzed by the same methods as the supernate samples after they were washed three times in 0.01 M NaOH before being submitted for chemical analysis. The samples were chemically and physically analyzed by inductively coupled plasma-optical emission spectrometry (ICP-OES), inductively coupled plasma-atomic emission spectrometry (ICP-AES), ion chromatography (IC), potentiometric titration for free OH, gravimetric measurement for density, and undissolved solids (UDS). However, not all samples were analyzed by all methods. The majority of the analyses were performed at Southwest Research Institute, Inc. (SWRI) with some of the analyses performed by PNNL. All chemical analyses were performed to the requirements of the Hanford Analytical Services Quality Assurance Requirements Documents, DOE/RL-96-68, HASQARD.

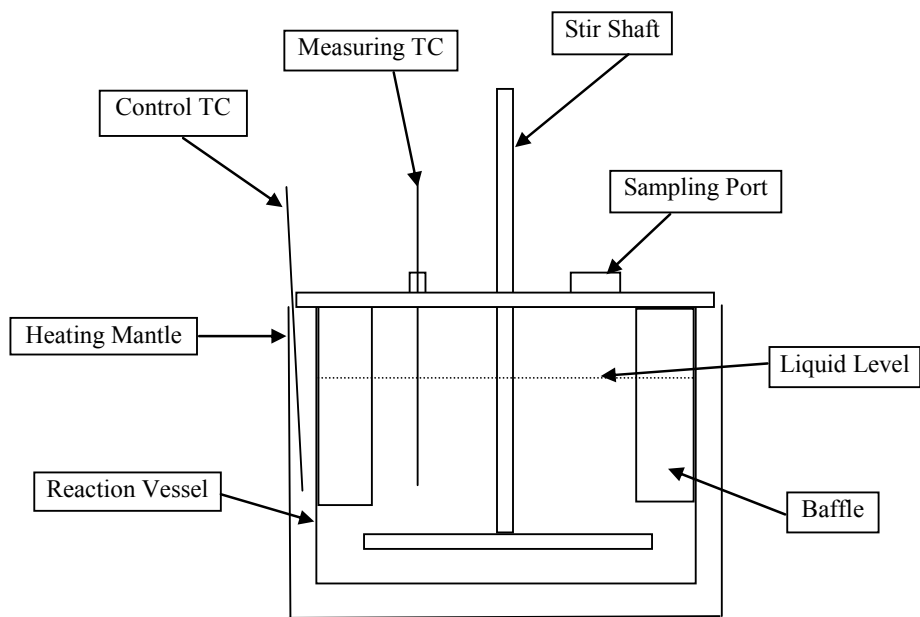

Figure 3.1. Schematic Drawing of the Caustic Leaching Test Setup

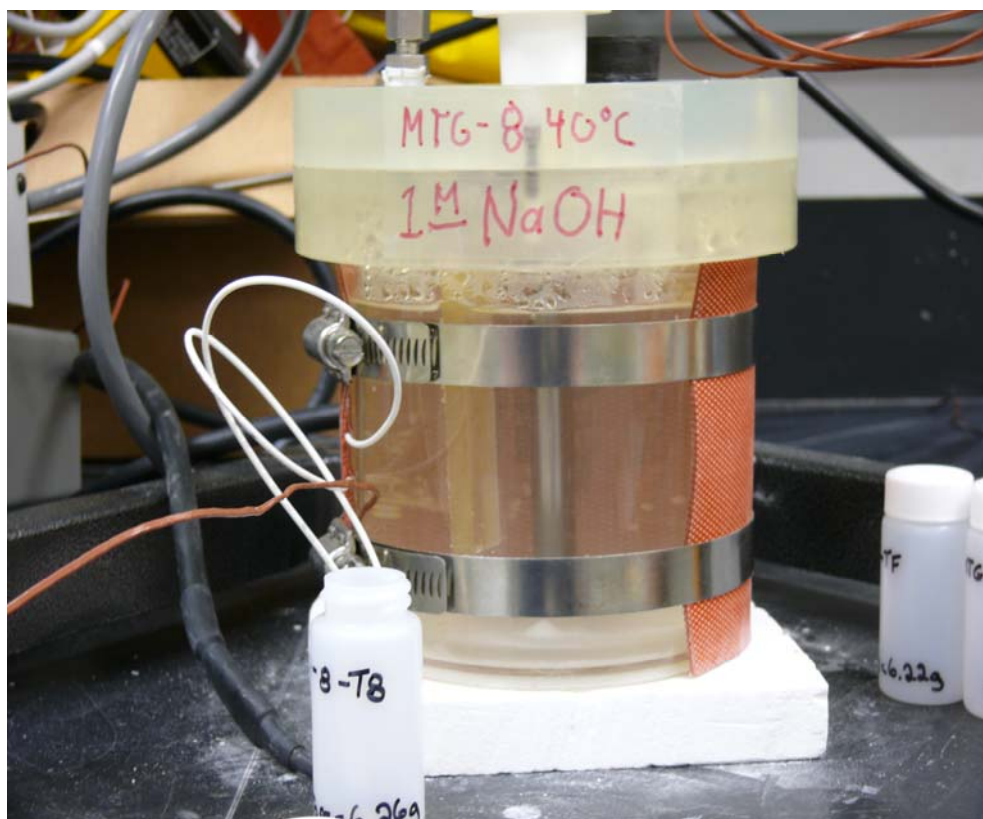

Figure 3.2. Simulant Leaching Vessel

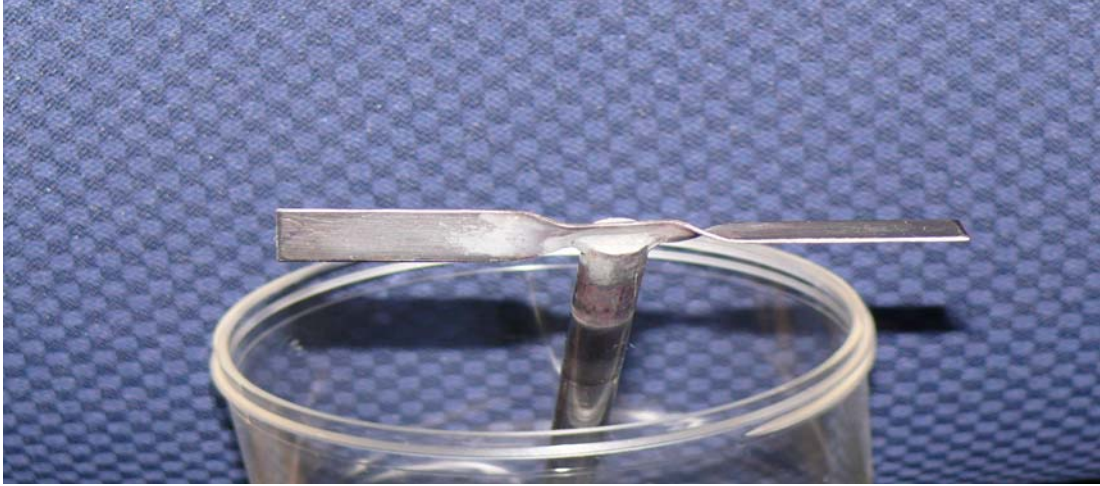

Figure 3.3. Simulant Leaching Vessel Stir Assembly

4.0 Model Input Boehmite Testing

The objective of these tests was to determine the effect of aluminate ion concentration and temperature on the rate of boehmite leaching. These tests were specified in ICN-TP-RPP-WTP-509_R0.5. Table 4.1 and Table 4.2 show the test matrices that were used for these tests. Boehmite type B3 indicates that Nabaltec APYRAL AOH20 was used, and boehmite type B7 indicates that Nabaltec APYRAL AOH180E was used. Boehmite type B3 was used in the PEP simulant for all of the PEP testing. The first 10 tests in Table 4.1 were designed to determine the impact of aluminate ion concentration on boehmite leaching. Tests 11 through 16 were designed to determine the effect of temperature on the boehmite dissolution, and tests 17 through 20 were designed to verify the effect of aluminate ion at lower reaction temperatures in the development of the boehmite dissolution rate equation.

The tests in Table 4.2 were also designed to determine the boehmite dissolution rate incorporating the impact of aluminate ion. These tests varied the amount of gibbsite present and determined the effect that it had on the boehmite dissolution. Data from tests in both Table 4.1 and Table 4.2 were all used in the boehmite dissolution rate equation development.

Table 4.1. Initial Set of Boehmite Model Input Tests

Test ID	Boehmite Type	Boehmite (g)	Gibbsite (g)	5 M NaOH (g)	Temperature (°C)	Mixing Speed (rpm)
B-AL1	B3	36.00	0.00	900.00	100	120
B-AL2	B3	36.00	5.06	900.00	100	120
B-AL3	B3	36.00	10.13	900.01	100	120
B-AL4	B3	36.00	15.20	899.99	100	120
B-AL5	B3	36.00	20.26	900.01	100	120
B-AL6	B3	36.00	25.33	900.01	100	120
B-AL7	B3	36.00	30.39	900.00	100	120
B-AL8	B3	36.00	40.52	900.02	100	120
B-AL9	B3	36.00	50.65	900.00	100	120
B-AL10	B3	36.00	60.78	900.01	100	120
B-AL11	B3	36.00	0.00	900.02	90	120
B-AL12	B3	36.01	0.00	900.00	85	120
B-AL13	B3	36.01	0.00	900.00	80	120
B-AL14	B7	36.00	0.00	900.01	90	120
B-AL15	B7	36.00	0.00	899.98	85	120
B-AL16	B7	36.01	0.00	900.00	80	120
B-AL17	B3	36.00	10.38	900.01	85	120
B-AL18	B3	36.01	20.76	900.00	85	120
B-AL19	B3	36.01	31.14	900.01	85	120
B-AL20	B3	36.01	41.52	900.00	85	120

Table 4.2. Second Set of Boehmite Model Input Tests

Test ID	Boehmite Type	Boehmite (g)	Gibbsite (g)	5M NaOH (g)	Temperature (°C)	Mixing Speed (rpm)
B-AL1a	B3	36.00	0.00	900.01	100	120
B-AL2a	B3	36.00	6.15	900.00	100	120
B-AL3a	B3	36.00	12.31	900.01	100	120
B-AL4a	B3	35.99	18.46	900.00	100	120
B-AL5a	B3	36.01	24.62	900.01	100	120
B-AL6a	B3	35.99	30.77	900.01	100	120
B-AL7a	B3	36.01	36.93	900.00	100	120
B-AL8a	B3	36.00	49.23	900.01	100	120
B-AL9a	B3	36.01	61.54	900.00	100	120
B-AL10a	B3	36.00	73.85	900.00	100	120

All of the tests in Table 4.1 and Table 4.2 were performed by placing 900 g of 5 M NaOH and the required amount of gibbsite in the test vessel, attaching the lid and heating to the leaching temperature over approximately 1 to 2 hours while stirring. When the vessel reached the target leaching temperature $\pm 2^\circ\text{C}$ and all of the gibbsite was completely dissolved, the initial sample was taken, and the boehmite was added. Samples of approximately 5-mL were taken with a 10-mL syringe through a sample port while stirring at 1, 2, 4, 8, 24, 30, and 48 hours and then filtered through a 0.45- μm syringe filter immediately. At the end of the first 10 tests shown in Table 4.1, the remaining solids were removed, washed three times with 0.01 M NaOH, dried, and weighed to determine how much solids were remaining for a material balance. The dry solids weights are shown in Table 4.3. The supernate samples were then analyzed by ICP-AES for Al and Na concentration, and the results are shown in Table 4.4 through Table 4.7 for both sets of tests. The model that was derived from this work is described and demonstrated in Appendix A.

Table 4.3. Dry-Solids Weight of Boehmite from the Model Input Leaching Tests

Test ID	Solids wt (g)	Test ID	Solids wt (g)
B-AL1	6.89	B-AL6	16.48
B-AL2	9.82	B-AL7	14.61
B-AL3	11.46	B-AL8	25.03
B-AL4	13.64	B-AL9	27.77
B-AL5	15.84	B-AL10	30.48

Table 4.4. Al Results for Filtrate from the Initial Set of Boehmite Model Input Leaching Tests

Time (hr)	B-AL1 (mg Al/kg soln)	B-AL2 (mg Al/kg soln)	B-AL3 (mg Al/kg soln)	B-AL4 (mg Al/kg soln)	B-AL5 (mg Al/kg soln)	B-AL6 (mg Al/kg soln)	B-AL7 (mg Al/kg soln)	B-AL8 (mg Al/kg soln)	B-AL9 (mg Al/kg soln)	B-AL10 (mg Al/kg soln)
0	<4.14	2,010	3,870	5,760	7,640	9,260	11,200	14,400	17,100	20,800
1	1,390	2,820	4,450	6,670	7,860	9,770	11,400	14,400	16,300	21,200
2	2,540	3,690	5,190	6,860	7,840	10,100	11,700	14,500	16,600	21,400
4	4,440	4,930	6,340	7,800	8,410	11,200	10,300	15,300	18,400	21,900
8	7,030	7,220	8,560	9,730	10,300	12,600	13,500	15,900	18,300	21,600
24	12,400	12,600	12,700	14,500	14,800	17,700	18,000	19,500	19,800	19,000
30	13,700	11,400	13,400	15,100	16,200	19,100	20,200	20,400	20,800	23,700
48	17,100	17,300	16,200	17,400	19,000	23,000	23,200	24,400	23,100	26,200
Final	17,400	16,800	16,000	17,700	19,300	23,400	23,500	24,400	22,300	25,400

Table 4.4 (cont)

Time (hr)	B-AL11 (mg Al/kg soln)	B-AL12 (mg Al/kg soln)	B-AL13 (mg Al/kg soln)	B-AL14 (mg Al/kg soln)	B-AL15 (mg Al/kg soln)	B-AL16 (mg Al/kg soln)	B-AL17 (mg Al/kg soln)	B-AL18 (mg Al/kg soln)	B-AL19 (mg Al/kg soln)	B-AL20 (mg Al/kg soln)
0	<4.38	<3.66	7.59	<3.92	<3.78	<3.85	3,660	7,140	11,000	15,200
0.25	253	146	115	895	647	288	3,740	7,680	11,100	15,000
0.50	429	265	193	1,860	1,150	527	3,670	7,710	11,100	15,300
0.75	614	370	263	2,710	1,580	764	3,950	7,730	10,900	15,000
1	802	473	332	3,480	1,770	917	3,950	7,590	11,700	15,300
2	1,410	847	528	5,870	3,490	1,740	3,990	7,790	12,100	15,000
4	2,580	1,490	912	9,320	5,930	3,210	4,200	7,980	11,200	15,100
8	4,090	2,480	1,470	12,700	9,360	5,600	4,640	7,750	11,700	14,900
24	7,780	5,510	3,460	18,000	15,300	10,700	6,590	9,260	13,100	14,600
30	8,920	6,350	4,150	18,100	16,000	11,200	7,170	9,850	13,000	15,400
48	11,200	8,290	5,800	20,100	17,700	12,400	8,420	11,400	13,800	16,200
Final	10,500	8,320	5,650	19,600	18,300	13,400	8,770	11,400	13,700	16,400

Table 4.5. Na Results for Filtrate from the Initial Set of Boehmite Model Input Leaching Tests

Time (hr)	B-AL1 (mg Na/kg soln)	B-AL2 (mg Na/kg soln)	B-AL3 (mg Na/kg soln)	B-AL4 (mg Na/kg soln)	B-AL5 (mg Na/kg soln)	B-AL6 (mg Na/kg soln)	B-AL7 (mg Na/kg soln)	B-AL8 (mg Na/kg soln)	B-AL9 (mg Na/kg soln)	B-AL10 (mg Na/kg soln)
0	87,900	86,500	89,400	90,100	88,100	86,900	87,100	85,800	80,800	78,400
1	89,400	92,000	87,100	92,700	89,000	88,700	86,600	84,900	75,300	81,600
2	87,800	92,000	88,700	87,600	87,200	88,000	86,900	85,200	77,600	81,800
4	91,900	89,400	89,500	88,500	84,900	88,900	71,100	87,800	82,900	82,900
8	94,800	90,200	93,700	90,800	88,700	91,300	86,200	88,700	80,700	82,300
24	98,100	96,100	89,900	92,100	89,100	96,400	89,100	93,900	81,300	74,100
30	100,000	79,100	87,900	89,900	91,500	97,400	92,800	95,000	82,700	85,500
48	105,000	104,000	91,300	90,500	95,100	101,000	93,000	103,000	85,800	90,600
Final	107,000	101,000	90,500	92,200	97,100	104,000	94,500	104,000	81,800	89,000

Table 4.5 (cont)

Time (hr)	B-AL11 (mg Na/kg soln)	B-AL12 (mg Na/kg soln)	B-AL13 (mg Na/kg soln)	B-AL14 (mg Na/kg soln)	B-AL15 (mg Na/kg soln)	B-AL16 (mg Na/kg soln)	B-AL17 (mg Na/kg soln)	B-AL18 (mg Na/kg soln)	B-AL19 (mg Na/kg soln)	B-AL20 (mg Na/kg soln)
0	87,600	90,300	90,800	92,800	91,400	90,500	89,000	81,300	82,800	88,700
0.25	91,400	89,800	90,600	87,400	87,400	92,500	89,000	86,600	83,400	88,400
0.50	88,600	90,800	89,300	92,100	90,700	92,400	86,600	87,000	83,500	89,200
0.75	91,600	88,900	89,500	92,600	90,700	92,700	91,600	86,600	83,000	89,400
1	92,400	89,400	91,600	92,000	81,600	91,400	92,000	85,000	89,600	89,900
2	92,900	88,500	87,600	92,900	92,200	88,300	90,500	85,400	91,600	87,000
4	93,000	89,800	91,000	91,900	90,800	88,400	89,800	86,400	85,300	89,000
8	95,900	89,000	85,100	88,900	91,700	88,400	89,700	80,700	88,000	87,200
24	94,100	91,300	91,600	103,000	95,900	92,500	92,300	84,900	92,300	83,200
30	96,400	93,600	91,400	102,000	94,200	87,700	92,200	85,600	90,300	88,000
48	99,300	93,300	93,700	109,000	97,800	86,700	91,000	90,300	89,700	90,400
Final	92,900	95,500	92,800	106,000	103,000	91,200	93,500	90,400	90,300	91,500

Table 4.6. Al Results for Filtrate from the Second Set of Boehmite Model Input Leaching Tests

Time (hr)	B-AL1a (mg Al/kg soln)	B-AL2a (mg Al/kg soln)	B-AL3a (mg Al/kg soln)	B-AL4a (mg Al/kg soln)	B-AL5a (mg Al/kg soln)	B-AL6a (mg Al/kg soln)	B-AL7a (mg Al/kg soln)	B-AL8a (mg Al/kg soln)	B-AL9a (mg Al/kg soln)	B-AL10a (mg Al/kg soln)
0	<3.62	2,210	4,410	6,840	9,060	11,200	12,900	17,600	22,000	26,200
0.25	543	2,490	4,630	6,610	8,800	11,100	13,500	17,600	20,800	26,200
0.50	950	2,600	5,050	6,950	9,160	11,200	13,400	17,400	21,000	26,400
0.75	1,320	2,770	4,770	7,060	9,160	11,400	13,800	17,700	20,800	25,700
1	1,610	2,940	5,300	7,280	8,860	11,000	13,000	18,100	21,000	27,200
2	2,850	3,870	5,990	7,570	9,440	11,700	13,800	16,700	21,000	27,400
4	4,720	5,380	7,280	8,060	10,200	12,700	14,400	18,100	21,600	27,300
8	7,400	7,910	9,220	10,000	11,600	13,600	15,600	18,600	21,900	26,500
24	12,800	13,000	13,500	14,400	15,400	17,800	18,900	20,900	23,700	28,200
30	14,900	14,800	14,600	16,200	16,600	19,100	18,800	21,100	23,900	29,100
48	16,900	16,800	17,900	18,200	18,700	24,400	20,600	22,100	26,400	31,200
Final	17,300	15,900	17,900	17,700	19,100	23,900	20,700	22,800	28,000	31,400

Table 4.7. Na Results for Filtrate from the Second Set of Boehmite Model Input Leaching Tests

Time (hr)	B-AL1a (mg Na/kg soln)	B-AL2a (mg Na/kg soln)	B-AL3a (mg Na/kg soln)	B-AL4a (mg Na/kg soln)	B-AL5a (mg Na/kg soln)	B-AL6a (mg Na/kg soln)	B-AL7a (mg Na/kg soln)	B-AL8a (mg Na/kg soln)	B-AL9a (mg Na/kg soln)	B-AL10a (mg Na/kg soln)
0	95,800	87,700	88,000	88,200	87,900	87,600	83,700	88,400	83,600	85,600
0.25	90,100	93,100	88,900	85,400	84,800	85,900	84,100	85,000	82,600	85,000
0.50	91,800	90,900	90,200	88,900	87,300	86,500	83,000	86,100	83,400	85,400
0.75	93,700	90,800	87,800	87,600	86,700	87,400	87,500	84,800	80,400	83,000
1	91,700	88,600	89,100	89,500	84,100	84,600	81,200	85,300	81,800	88,500
2	94,300	90,800	90,000	88,400	86,500	88,300	85,300	79,000	82,400	89,100
4	91,600	90,000	90,900	83,800	87,000	86,400	85,900	85,700	83,600	89,000
8	92,300	92,500	91,500	87,500	88,200	87,100	87,600	86,700	83,800	87,000
24	98,500	91,000	89,200	87,200	87,300	94,800	87,100	88,900	88,200	92,100
30	101,000	92,800	88,600	90,200	88,500	96,700	86,500	87,300	85,900	93,800
48	105,000	95,100	95,300	89,300	89,400	103,000	86,400	86,200	92,400	101,000
Final	107,000	90,100	95,600	87,000	91,300	101,000	86,700	89,400	92,200	102,000

5.0 PEP Support Leaching Tests

The objective of these tests was to determine the effect of temperature and aeration on the extent of chromium dissolution during caustic leaching and to determine the rate and extent of dissolution of aluminum under UFP-T01A/B caustic leaching conditions.

Tests specified in ICN-TP-RPP-WTP-509_R0.3 were performed according to the test matrix shown in Table 5.1. WTP staff were responsible for interpreting these data and for assessing the impact of the data on planned PEP operations. As such, the data are presented herein, but there is no interpretation provided.

In addition, a second set of tests was required so the current kinetics model for boehmite dissolution in the presence of gibbsite (predictions) could be confirmed before the PEP testing. These tests were specified in ICN-TP-RPP-WTP-509_R0.5. These tests were performed according to the test matrix shown in Table 5.2. Hydroxide concentration was not measured as it was assumed that the amount added was correct. WTP staff were responsible for interpreting these data and for assessing the impact of the data on planned PEP operations. As such, the data are presented herein, but there is no interpretation provided. Also note that there was some evaporation of water throughout the test; however, no attempt has been made to determine the quantity of water evaporated or to perform a material balance for these tests.

Table 5.1. Test Matrix for the PEP Support Leaching Tests

Test ID	Initial Wt% Solids	250 Gal Batch PEP Simulant (g)	CrOOH Slurry (g)	19M NaOH (g)	DI water (g)	Leach Temperature (°C)
PST-1	20	481.90	118.16	381.83	105.41	100
PST-2	20	481.90	118.16	381.83	105.41	95
PST-3	20	481.90	118.16	381.83	105.41	85
PST-4	20	481.90	118.16	381.83	105.41	80
PST-5	5	596.34	40.62	192.27	100.63	100
PST-6	5	596.34	40.62	192.27	100.63	95
PST-7	5	596.34	40.62	192.27	100.63	85
PST-8	5	596.34	40.62	192.27	100.63	80
PST-9	20	481.90	118.16	381.83	105.41	85

Table 5.2. Test Matrix for the PEP Support Leaching Tests #2

Test ID	Initial Wt% Solids	250 Gal Batch PEP Simulant (g)	19M NaOH (g)	DI water (g)	Leach Temperature (°C)
PST2-1	5	576.01	145.04	79.02	98
PST2-2	20	449.01	261.02	90.08	98
PST2-3	5	513.00	209.01	78.01	80
PST2-4	20	332.00	379.00	89.08	80
PST2-5	5	538.01	182.98	79.01	98
PST2-6	5	510.00	211.99	78.02	85
PST2-7	20	388.01	323.02	89.02	85

All of these tests were performed by placing the correct amount of PEP simulant with the appropriate wt% UDS into the test vessel. The CrOOH slurry (if needed), deionized (DI) water, and 19 M NaOH were added to it. The lid was attached, and stirring at 120 rpm was initiated. PST-9 was aerated at ~85-mL/min per the rotometer reading at laboratory conditions during the test with air being injected into the slurry below the surface near the bottom of the vessel. Two initial samples were removed (one as supernatant and one as slurry), and then it was heated to temperature over a 6-hour timeframe. When the test vessel reached the appropriate temperature after 6 hours, another sample was removed as the time 0 sample. Then 5-mL supernatant samples were obtained while stirring at 1, 2, 4, 8, 12, 16, 20, and 24 hours by filtering slurry through a 0.45- μ m syringe filter immediately for both sets of tests as well as 3, 5, and 6 hours for the second set of tests. The slurry samples were washed three times with 0.01 M NaOH and were then analyzed by ICP-AES for Al, Cr, and Na concentration. The results from the slurry samples from the first set of tests are shown in Table 5.3. The supernate was also analyzed for Al, Cr, and Na by ICP-AES, and the results are shown in Table 5.4 through Table 5.6 for the first set of tests. The slurry samples from the second set of tests were analyzed by ICP-AES for Al, Fe, and Na and the results are shown in Table 5.7. The supernatant samples from the second set of tests were analyzed by ICP-AES for Al and Na with the results shown in Table 5.8 and Table 5.9.

Table 5.3. Results for Solids from the PEP Support Leaching Tests

	PST-1-INS (mg/kg slurry)	PST-2-INS (mg/kg slurry)	PST-3-INS (mg/kg slurry)	PST-4-INS (mg/kg slurry)	PST-5-INS (mg/kg slurry)	PST-6-FIS (mg/kg slurry)	PST-7-FIS (mg/kg slurry)	PST-8-FIS (mg/kg slurry)	PST-9-FIS (mg/kg slurry)
Al	19,600	19,300	17,900	18,300	9,040	8,880	9,020	9,030	20,600
Cr	1,020	1,020	1,030	1,010	407	400	392	406	1,005
Na	139,000	135,000	139,000	134,000	115,000	113,000	112,000	111,000	132,000

Table 5.3 (cont)

	PST-1-FWS (mg/kg slurry)	PST-2-FWS (mg/kg slurry)	PST-3-FWS (mg/kg slurry)	PST-4-FWS (mg/kg slurry)	PST-5-FWS (mg/kg slurry)	PST-6-FWS (mg/kg slurry)	PST-7-FWS (mg/kg slurry)	PST-8-FWS (mg/kg slurry)	PST-9-FWS (mg/kg slurry)
Al	83,600	89,400	110,000	104,000	63,800	68,200	69,900	63,700	94,600
Cr	4,690	4,440	4,340	4,210	2,610	2,010	2,720	2,700	3,620
Na	19,500	12,800	11,200	18,400	3,220	17,800	3,710	2,390	5,670

5.3

Table 5.4. Al Results for Filtrate from the PEP Support Leaching Tests

Time (hr)	PST-1 (mg Al/kg soln)	PST-2 (mg Al/kg soln)	PST-3 (mg Al/kg soln)	PST-4 (mg Al/kg soln)	PST-5 (mg Al/kg soln)	PST-6 (mg Al/kg soln)	PST-7 (mg Al/kg soln)	PST-8 (mg Al/kg soln)	PST-9 (mg Al/kg soln)
Initial	5,450	4,890	5,020	4,980	2,570	2,730	2,630	2,680	5,560
0	12,300	12,100	10,600	10,700	5,440	5,430	5,430	5,540	10,700
1	12,600	12,300	11,000	10,600	5,550	5,820	4,990	5,260	10,600
2	12,500	12,700	11,100	10,900	5,620	5,470	5,340	5,200	10,600
4	13,300	11,800	11,100	11,100	5,930	5,830	5,300	5,680	10,900
8	13,400	12,600	11,100	11,200	6,080	5,830	5,420	5,430	11,400
12	16,300	14,100	11,300	11,100	6,610	6,100	5,580	5,480	11,800
16	17,500	15,600	11,600	11,200	6,790	6,530	5,940	5,610	12,200
20	18,700	16,600	11,700	11,200	7,420	6,920	5,860	5,670	12,300
24	20,000	17,900	12,200	11,500	7,700	7,470	5,740	5,770	13,100
Final	18,400	15,600	11,400	11,300	7,570	7,150	5,520	5,670	13,400

Table 5.5. Cr Results for Filtrate from the PEP Support Leaching Tests

Time (hr)	PST-1 (mg Cr/kg soln)	PST-2 (mg Cr/kg soln)	PST-3 (mg Cr/kg soln)	PST-4 (mg Cr/kg soln)	PST-5 (mg Cr/kg soln)	PST-6 (mg Cr/kg soln)	PST-7 (mg Cr/kg soln)	PST-8 (mg Cr/kg soln)	PST-9 (mg Cr/kg soln)
Initial	57.6	58.5	62.8	60.8	12.1	17.6	17.3	17.8	79.3
0	403	387	344	323	161	155	135	123	376
1	418	398	384	356	177	181	147	140	407
2	422	424	397	378	187	184	167	154	422
4	452	449	417	397	211	213	181	187	454
8	457	494	454	433	236	237	218	207	523
12	553	520	490	454	274	271	246	235	572
16	591	575	525	487	278	304	282	256	625
20	629	614	562	529	309	332	291	275	655
24	660	669	608	562	321	351	297	294	724
Final	657	635	593	549	319	343	286	284	723

5.4

Table 5.6. Na Results for Filtrate from the PEP Support Leaching Tests

Time (hr)	PST-1 (mg Na/kg soln)	PST-2 (mg Na/kg soln)	PST-3 (mg Na/kg soln)	PST-4 (mg Na/kg soln)	PST-5 (mg Na/kg soln)	PST-6 (mg Na/kg soln)	PST-7 (mg Na/kg soln)	PST-8 (mg Na/kg soln)	PST-9 (mg Na/kg soln)
Initial	140,000	139,000	142,000	139,000	114,000	114,000	112,000	109,000	136,000
0	144,000	144,000	138,000	138,000	117,000	116,000	119,000	122,000	141,000
1	144,000	142,000	142,000	138,000	115,000	124,000	117,000	118,000	140,000
2	142,000	146,000	143,000	141,000	119,000	116,000	116,000	113,000	140,000
4	144,000	146,000	143,000	142,000	116,000	133,000	113,000	121,000	141,000
8	134,000	148,000	144,000	144,000	116,000	116,000	117,000	115,000	146,000
12	149,000	144,000	140,000	140,000	119,000	119,000	119,000	117,000	148,000
16	148,000	150,000	142,000	141,000	116,000	121,000	126,000	119,000	150,000
20	152,000	152,000	141,000	142,000	116,000	124,000	119,000	123,000	149,000
24	149,000	158,000	144,000	143,000	118,000	128,000	117,000	122,000	153,000
Final	151,000	149,000	140,000	142,000	115,000	126,000	117,000	119,000	156,000

Table 5.7. Results for Solids from the PEP Support Leaching Tests #2

	PST2-1- FWS (mg/kg slurry)	PST2-2- FWS (mg/kg slurry)	PST2-3- FWS (mg/kg slurry)	PST2-4- FWS (mg/kg slurry)	PST2-5- FWS (mg/kg slurry)	PST2-6- FWS (mg/kg slurry)	PST2-7-FWS (mg/kg slurry)	Initial 5-wt% UDS (mg/kg slurry)	Initial 20-wt% UDS (mg/kg slurry)
Al	183,000	133,000	215,000	223,000	142,000	229,000	211,000	255,000	283,000
Fe	212,000	228,000	170,000	170,000	237,000	155,000	141,000	114,000	87,300
Na	14,000	29,000	<9,100	<9,200	11,000	[19,000]	[24,000]	<9,000	<8.700

Brackets indicate that the value is > method detection limit but < estimated quantitative limit.

Table 5.8. Al Results for Filtrate from the PEP Support Leaching Tests #2

Time (hr)	PST2-1 (mg Al/L soln)	PST2-2 (mg Al/L soln)	PST2-3 (mg Al/L soln)	PST2-4 (mg Al/L soln)	PST2-5 (mg Al/L soln)	PST2-6 (mg Al/L soln)	PST2-7 (mg Al/L soln)
Initial	2,620	2,340	2,540	1,920	2,560	2,980	2,850
0	4,020	4,940	3,780	3,220	3,930	5,900	12,300
1	4,020	5,090	3,810	2,850	3,980	5,980	12,500
2	4,070	5,370	3,810	3,250	4,140	5,960	12,600
3	4,060	5,470	3,840	2,900	4,200	6,100	12,700
4	4,260	5,730	3,860	3,150	4,280	6,180	13,000
5	4,230	5,820	3,860	3,400	4,390	6,080	12,600
6	4,240	6,000	3,720	3,540	4,610	6,230	13,200
8	4,380	6,270	3,780	3,140	4,860	6,260	13,400
12	4,640	6,830	3,830	3,760	5,180	6,380	14,000
16	4,890	7,470	3,840	3,970	5,590	6,580	14,700
20	5,060	8,120	3,860	4,150	5,940	6,660	15,300
24	5,300	8,370	3,980	4,290	6,150	6,940	15,900
Final	5,380	8,470	3,980	4,390	6,190	6,770	16,000

Table 5.9. Na Results for Filtrate from the PEP Support Leaching Tests #2

Time (hr)	PST2-1 (mg Na/L soln)	PST2-2 (mg Na/L soln)	PST2-3 (mg Na/L soln)	PST2-4 (mg Na/L soln)	PST2-5 (mg Na/L soln)	PST2-6 (mg Na/L soln)	PST2-7 (mg Na/L soln)
Initial	140,000	181,000	164,000	217,000	152,000	166,000	204,000
0	140,000	180,000	165,000	220,000	155,000	170,000	210,000
1	141,000	178,000	166,000	218,000	156,000	170,000	209,000
2	139,000	183,000	164,000	222,000	157,000	169,000	212,000
3	140,000	181,000	167,000	219,000	160,000	169,000	212,000
4	143,000	184,000	167,000	220,000	161,000	170,000	214,000
5	141,000	183,000	166,000	222,000	161,000	171,000	211,000
6	138,000	181,000	165,000	220,000	166,000	172,000	212,000
8	143,000	183,000	165,000	219,000	168,000	172,000	215,000
12	142,000	185,000	167,000	222,000	170,000	173,000	215,000
16	144,000	186,000	168,000	226,000	175,000	172,000	216,000
20	142,000	186,000	163,000	222,000	177,000	173,000	218,000
24	145,000	185,000	169,000	222,000	176,000	172,000	218,000
Final	147,000	191,000	168,000	220,000	182,000	171,000	220,000

6.0 PEP Parallel Leaching Tests

The objectives of these tests were to provide data to support the development of scale factors between laboratory process measurements and those of PEP. These tests are specified in Test Plan TP-WTP-PEP-044, Rev. 0.2 and were carried out as specified by WTP for each PEP test that was performed.

Four laboratory-scale caustic-leach tests were performed to support the PEP functional tests (Section 6.1), and two laboratory-scale caustic-leach tests were performed to support each of PEP Test A (Section 6.2), Test B (Section 6.3), and Test D (Section 6.4). Four laboratory-scale oxidative-leach tests were performed to support PEP Test A, Test B, and Test D with one test each for PEP Test A and PEP Test B. There were two tests for PEP Test D with different amounts of permanganate added (Section 6.5). The analysis of test results presented in this section is reported in WTP-RPT-186 (Mahoney et al. 2009) and WTP-RPT-188 (Rapko et al. 2009). Integrated PEP Test C was deleted from the scope of the testing (ICN-TP-RPP-WTP-506_R0.2).

6.1 PEP Functional Test Caustic Leach

The PEP Functional Test was conducted under three Test Instructions, TI-WTP-PEP-062 (TI-062), TI-WTP-PEP-067 (TI-067), and TI-WTP-PEP-032 (TI-032). The scope of TI-067 included collecting data from UFP-VSL-T01A. Data from the UFP-VSL-T01A and UFP-VSL-T02A leach processes was collected during test TI-032. TI-062 included caustic addition only.

According to TI-032, simulant stored in HLP-VSL-T22 was transferred into vessel UFP-VSL-T01A. A sample of the feed slurry (without added caustic) was taken from the inner Coriolis densitometer (CD) sample loop at the middle-elevation port in UFP-VSL-T01A for use as feed in the laboratory-scale caustic leach tests (PL_LAB_CL_3). This slurry sample was taken on December 20, 2008 at 9:23.

An anti-foaming agent (AFA), Dow Corning Q2-3183A, was added directly to UFP-VSL-T01A in a quantity expected to produce a nominal concentration of 350 ppm in the slurry. After this addition, caustic reagent (nominally 19 M NaOH) was injected into the feed transfer line and added directly into UFP-VSL-T01A. This was thoroughly mixed for 30 minutes, and then another sample of slurry (comprising feed plus caustic and AFA) was taken from the inner CD sample loop at the middle-elevation port in UFP-VSL-T01A for use as feed in the laboratory-scale caustic leach tests (PL_LAB_CL_1). This slurry sample was taken on December 20, 2008 at 10:38. The sample, when taken, was at 71°C and was rapidly cooled to ambient temperature (approximately 20°C to 25°C) to minimize any further leaching reaction.

For the samples taken from the UFP-VSL-T02A tank, feed stored in HLP-VSL-T22 was transferred into vessel UFP-VSL-T01A. AFA was added directly to UFP-VSL-T01A in a quantity expected to produce a nominal concentration of 350 ppm in the slurry. The slurry was then transferred from the UFP-VSL-T01A feed tank to UFP-VSL-T02A, and permeate was removed from UFP-VSL-T02A through the first ultrafilter bundle to increase the solids concentration of the slurry. As permeate was removed, the volume (and level) in UFP-VSL-T02A fell, triggering the transfer of small refill batches (i.e., 11 gal) of fresh simulant from UFP-VSL-T01A. The filtering and refill process continued, leaving a target quantity of slurry at about 20-wt% UDS in the UFP-VSL-T02A vessel and filter loop. When the

solids concentration process was complete, a sample of the feed slurry (without added caustic) was taken from the inner CD sample loop at the middle-elevation port in UFP-VSL-T02A for use as feed in the laboratory-scale caustic leach tests (PL_LAB_CL_4). This slurry sample was taken on January 2, 2009 at 7:19.

A solution of 19M caustic was added upstream of the filter loop pumps while the slurry was circulated through the loop. The caustic slurry in UFP-VSL-T02A was heated to about 71°C using the heat of dilution of the concentrated NaOH and mechanical heat from the filter loop recirculation pumps. The filter loop pumps were then turned off, and a portion of the concentrated slurry in the filter loop was flushed back into UFP-VSL-T02A before the loop was closed off from the vessel. Because the total loop volume (82 gal, excluding dead volumes) was significantly greater than the flush volume (~46 gal), none of the flush solution (0.01 M NaOH) is expected to have entered the vessel. After the flush, a sample of slurry was taken from the middle-low region of vessel UFP-VSL-T02A using the CD sampler for use as feed in the laboratory-scale caustic leach test (PL_LAB_CL_2). The sample was rapidly cooled to ambient temperature (approximately 20°C to 25°C) to minimize any further leaching reaction. This slurry sample was taken on January 2, 2009 at 11:41.

The laboratory-scale feed was stored at laboratory ambient temperature until it was used. The delay between the time when the feed was acquired from PEP and the time laboratory-scale testing started was about 23 days for tests PL_LAB_CL_1 and PL_LAB_CL_3 (from December 20, 2008 to January 12, 2009) and about 10 days for tests PL_LAB_CL_2 and PL_LAB_CL_4 (from January 2, 2009 to January 12, 2009).

The PEP sample ID, laboratory sample ID, and the amounts of components used in the functional laboratory-scale tests are shown in Table 6.1.

Table 6.1. PEP Parallel Functional Test Matrix

PEP Test ID	Lab Test ID	Test Matrix	PEP Simulant (g)	19 M NaOH (g)	DI Water (g)
S_01AML_020_XX_0749_CUF_4	PL_LAB_CL_1	After Caustic Addition to UFP-T01A	702.83	---	97.19
S_02_AML_017_XX_0977_CUF_4	PL_LAB_CL_2	After Caustic Addition to UFP-T02A	662.60	---	137.39
S_01AIM_020_XX_0748_CUF_4	PL_LAB_CL_3	Before Caustic Addition to UFP-T01A	538.30	156.40	105.30
S_02AML_015_XX_0976_CUF_4	PL_LAB_CL_4	Before Caustic Addition to UFP-T02A	356.72	290.81	152.61

These tests were performed by placing the required amount of PEP simulant, 19 M NaOH, and DI water in the test vessel, attaching the lid, and heating to 58°C for tests PL_LAB_CL_1 and PL_LAB_CL_3 and to 71°C for tests PL_LAB_CL_2 and PL_LAB_CL_4 while stirring at 120 rpm. After reaching the target temperature for each test, the vessel contents were heated at a linear rate to $98 \pm 2^\circ\text{C}$ over a 3-hour time span. When the vessel reached $88 \pm 2^\circ\text{C}$, a sample was taken to represent the collection at -10°C below the leaching temperature and was labeled as the “-0.85 hr” sample. At $98 \pm 2^\circ\text{C}$, the time zero (0 hr) sample was taken, and the test was held for 24 hours at this temperature. Samples were taken at 1, 2, 4, 8, 10, 12, 14, 16, 20, 22, and 24 hours and immediately filtered through a 0.45- μm syringe filter. These samples were then analyzed by ICP-AES for Al, Cr, and Na concentration at SWRI, and the results are shown in Table 6.2 through Table 6.4. Slurry samples were also taken at the beginning and end of the test. Some slurry samples were washed three times with 0.01 M NaOH, and others were not washed. These samples were analyzed by ICP-AES for major cations at SWRI, and these results are shown in Table 6.5 through Table 6.8. The samples were also analyzed by ion chromatography (IC) for anion concentrations, which are shown in Table 6.9 through Table 6.12 for the supernate and Table 6.13 for the slurries. The density and wt% solids of the initial slurry for each test were measured by SWRI using pycnometers for the density, and the slurry and supernate were dried for the wt% solids. These results are shown in Table 6.14 and Table 6.15. The OH^- was titrated in the supernate samples by SWRI, and the results are shown in Table 6.16 in terms of milli-equivalents per gram (meq/g).

Table 6.2. Supernate Al Analysis from PEP Functional Test Caustic Leach

Time (hrs)	Temp. ($^\circ\text{C}$)	PL_LAB_CL_1 (mg Al/kg soln)	PL_LAB_CL_2 (mg Al/kg soln)	PL_LAB_CL_3 (mg Al/kg soln)	PL_LAB_CL_4 (mg Al/kg soln)
Initial	25.1	4,640	11,100	2,370	3,940
-0.85	88.1	7,120	12,100	6,720	12,000
0	99.2	7,200	12,500	6,850	12,100
1	99.1	7,150	12,800	6,990	12,800
2	99.0	7,370	13,200	7,000	13,100
4	99.0	7,670	14,100	7,280	13,900
8	98.5	8,600	16,800	7,680	No sample
10	98.9	8,800	16,300	8,020	No sample
12	98.9	9,050	16,800	8,390	17,300
14	98.9	9,600	17,500	8,640	17,700
16	98.6	10,100	18,100	8,970	18,600
18	99.0	10,400	19,000	9,420	19,100
20	99.1	10,500	18,500	9,590	19,600
22	99.1	10,800	19,800	9,870	20,100
24	99.1	11,100	19,500	10,100	20,900

Table 6.3. Supernate Cr Analysis from PEP Functional Test Caustic Leach

Time (hrs)	Temp. (°C)	PL_LAB_CL_1 (mg Cr/kg soln)	PL_LAB_CL_2 (mg Cr/kg soln)	PL_LAB_CL_3 (mg Cr/kg soln)	PL_LAB_CL_4 (mg Cr/kg soln)
Initial	25.1	1.16	1.54	1.10	0.85
-0.85	88.1	1.26	2.22	1.19	1.36
0	99.2	1.29	2.46	1.30	1.57
1	99.1	1.30	2.55	1.36	1.67
2	99.0	1.35	2.61	1.32	1.76
4	99.0	1.38	2.77	1.38	1.88
8	98.5	1.51	3.24	1.52	No sample
10	98.9	1.49	3.01	1.50	No sample
12	98.9	1.51	3.08	1.51	2.09
14	98.9	1.62	3.14	1.48	2.10
16	98.6	1.63	3.25	1.48	2.14
18	99.0	1.65	3.38	1.59	2.21
20	99.1	1.62	3.22	1.56	2.21
22	99.1	1.69	3.37	1.69	2.26
24	99.1	1.74	3.41	1.72	2.30

Table 6.4. Supernate Na Analysis from PEP Functional Test Caustic Leach

Time (hrs)	Temp. (°C)	PL_LAB_CL_1 (mg Na/kg soln)	PL_LAB_CL_2 (mg Na/kg soln)	PL_LAB_CL_3 (mg Na/kg soln)	PL_LAB_CL_4 (mg Na/kg soln)
Initial	25.1	131,000	149,000	129,000	159,000
-0.85	88.1	133,000	160,000	124,000	151,000
0	99.2	132,000	163,000	124,000	150,000
1	99.1	130,000	163,000	123,000	151,000
2	99.0	133,000	163,000	123,000	151,000
4	99.0	132,000	164,000	124,000	152,000
8	98.5	139,000	167,000	124,000	No sample
10	98.9	132,000	165,000	124,000	No sample
12	98.9	137,000	165,000	123,000	154,000
14	98.9	142,000	167,000	127,000	153,000
16	98.6	144,000	171,000	127,000	152,000
18	99.0	145,000	174,000	132,000	154,000
20	99.1	144,000	171,000	131,000	154,000
22	99.1	145,000	174,000	132,000	156,000
24	99.1	147,000	174,000	132,000	158,000

Table 6.5. Slurry Analysis from PEP Functional Test Caustic Leach Test 1

	A_LAB_ CL_1_IN_SL (mg/kg slurry)	A_LAB_ CL_1_IS_SL (mg/kg slurry)	A_LAB_ CL_1_FS1_SL (mg/kg slurry)	A_LAB_ CL_1_FS2_SL (mg/kg slurry)	A_LAB_ CL_1_FS3_SL (mg/kg slurry)
	Test 1 Initial				
Sample Description	Unwashed Slurry	Test 1 Initial Washed Slurry	Test 1 Final Washed Slurry -1	Test 1 Final Washed Slurry -2	Test 1 Final Washed Slurry -3
Al	9,850	27,200	15,100	16,900	39,000
Ca	96.9	511	653	675	648
Cr	1.66	3.08	2.17	2.08	15.5
Fe	3,070	16,400	20,300	20,800	20,200
Mg	65.0	348	434	440	432
Mn	671	3,450	4,180	4,230	4,100
Ni	93.6	507	629	644	629
Na	125,000	901	1,270	1,400	1,290
P	1,280	146	202	231	255
Sr	27.2	138	168	173	169
Zr	82.4	384	458	466	524

Table 6.6. Slurry Analysis from PEP Functional Test Caustic Leach Test 2

	A_LAB_ CL_2_IN_SL (mg/kg slurry)	A_LAB_ CL_2_IS_SL (mg/kg slurry)	A_LAB_ CL_2_FS1_SL (mg/kg slurry)	A_LAB_ CL_2_FS2_SL (mg/kg slurry)	A_LAB_ CL_2_FS3_SL (mg/kg slurry)
	Test 2 Initial				
Sample Description	Unwashed Slurry	Test 2 Initial Washed Slurry	Test 2 Final Washed Slurry -1	Test 2 Final Washed Slurry -2	Test 2 Final Washed Slurry -3
Al	19,700	22,500	37,000	41,200	42,400
Ca	229	1,030	1,220	1,230	1,250
Cr	3.20	17.0	32.9	33.4	33.8
Fe	7,260	32,700	38,600	38,900	39,600
Mg	155	708	811	821	834
Mn	1,630	6,630	7,750	7,800	8,070
Ni	221	1,010	1,200	1,210	1,240
Na	141,000	2,050	3,060	3,090	3,240
P	756	101	217	175	199
Sr	64.5	274	325	322	329
Zr	196	695	712	371	323

Table 6.7. Slurry Analysis from PEP Functional Test Caustic Leach Test 3

	A_LAB_ CL_3_IN_SL (mg/kg slurry)	A_LAB_ CL_3_IS_SL (mg/kg slurry)	A_LAB_ CL_3_FS1_SL (mg/kg slurry)	A_LAB_ CL_3_FS2_SL (mg/kg slurry)	A_LAB_ CL_3_FS3_SL (mg/kg slurry)
	Test 3 Initial				
Sample Description	Unwashed Slurry	Test 3 Initial Washed Slurry	Test 3 Final Washed Slurry -1	Test 3 Final Washed Slurry -2	Test 3 Final Washed Slurry -3
Al	8,790	37,500	17,700	18,100	17,100
Ca	98.1	491	629	635	635
Cr	1.52	3.20	2.18	2.05	2.00
Fe	3,050	15,600	19,700	20,000	20,000
Mg	65.5	339	422	435	418
Mn	678	3,300	4,060	4,080	4,070
Ni	94.2	484	608	620	624
Na	122,000	823	1,370	1,220	1,190
P	714	79.1	298	183	195
Sr	27.2	133	166	171	167
Zr	68.9	409	429	472	469

Table 6.8. Slurry Analysis from PEP Functional Test Caustic Leach Test 4

	A_LAB_ CL_4_IN_SL (mg/kg slurry)	A_LAB_ CL_4_IS_SL (mg/kg slurry)	A_LAB_ CL_4_FS1_SL (mg/kg slurry)	A_LAB_ CL_4_FS2_SL (mg/kg slurry)	A_LAB_ CL_4_FS3_SL (mg/kg slurry)
	Test 4 Initial				
Sample Description	Unwashed Slurry	Test 4 Initial Washed Slurry	Test 4 Final Washed Slurry -1	Test 4 Final Washed Slurry -2	Test 4 Final Washed Slurry -3
Al	20,000	60,200	32,000	31,100	31,400
Ca	222	857	1,200	1,210	1,180
Cr	2.53	27.8	32.9	30.6	31.0
Fe	6,850	26,800	38,500	38,500	38,000
Mg	151	579	801	818	801
Mn	1,560	5,590	7,750	7,750	7,680
Ni	220	830	1,210	1,200	1,190
Na	146,000	1,740	2,900	3,010	2,910
P	448	74.2	207	247	173
Sr	62.0	228	320	321	312
Zr	187	703	633	683	504

Table 6.9. Anion Analysis of PL_LAB_CL_1 Supernate

Time (hrs)	Temp. (°C)	Chloride (mg/kg soln)	Nitrate (mg/kg soln)	Nitrite (mg/kg soln)	Oxalate (mg/kg soln)	Phosphate (mg/kg soln)	Sulfate (mg/kg soln)
Initial	25.1	964	58,000	13,100	164	2,030	10,200
-0.85	88.1	810	60,700	13,400	197	4,110	10,400
0	99.2	836	62,400	13,900	192	4,170	10,600
1	99.1	811	60,200	13,400	189	4,050	10,400
2	99.0	835	61,600	13,600	176	4,080	10,400
4	99.0	869	63,300	14,000	173	4,170	10,700
8	98.5	858	63,300	14,100	159	4,200	10,800
10	98.9	865	63,300	14,100	152	4,200	10,800
12	98.9	860	63,300	14,200	164	4,200	10,800
14	98.9	875	64,700	14,400	149	4,260	10,800
16	98.6	898	66,000	14,700	141	4,320	11,100
18	99.0	901	66,900	14,900	137	4,380	11,100
20	99.1	928	67,300	15,000	170	4,410	11,100
22	99.1	929	68,600	15,200	145	4,470	11,200
24	99.1	952	69,500	15,500	150	4,440	11,300

Table 6.10. Anion Analysis of PL_LAB_CL_2 Supernate

Time (hrs)	Temp. (°C)	Chloride (mg/kg soln)	Nitrate (mg/kg soln)	Nitrite (mg/kg soln)	Oxalate (mg/kg soln)	Phosphate (mg/kg soln)	Sulfate (mg/kg soln)
Initial	25.1	666	37,700	8,670	71.7	1,410	7,030
-0.85	88.1	525	39,200	8,900	135	2,790	7,330
0	99.2	510	39,100	9,000	109	2,750	7,230
1	99.1	538	39,600	9,070	94.4	2,860	7,330
2	99.0	525	39,400	9,040	94.2	2,790	7,430
4	99.0	537	39,900	9,070	108	1,080	7,370
8	98.5	552	40,500	9,920	73.4	2,810	7,810
10	98.9	529	39,900	9,170	85.4	2,680	7,420
12	98.9	522	39,900	9,230	79.0	2,700	7,510
14	98.9	544	40,500	9,360	84.2	2,610	7,570
16	98.6	558	41,200	9,430	75.5	2,720	7,620
18	99.0	532	39,300	9,330	63.6	2,220	7,510
20	99.1	566	42,200	9,590	78.0	2,690	7,770
22	99.1	564	42,100	9,630	79.3	1,020	7,810
24	99.1	549	40,800	9,300	76.8	2,590	7,510

Table 6.11. Anion Analysis of PL_LAB_CL_3 Supernate

Time (hrs)	Temp. (°C)	Chloride (mg/kg soln)	Nitrate (mg/kg soln)	Nitrite (mg/kg soln)	Oxalate (mg/kg soln)	Phosphate (mg/kg soln)	Sulfate (mg/kg soln)
Initial	25.1	978	60,200	13,400	264	1,960	10,400
-0.85	88.1	819	58,500	13,000	213	3,980	10,100
0	99.2	805	57,600	12,900	203	3,800	9,960
1	99.1	830	59,300	13,300	205	1,760	10,400
2	99.0	829	58,500	13,000	208	3,950	10,100
4	99.0	819	58,500	13,100	209	3,920	10,200
8	98.5	818	58,900	13,200	242	3,920	10,300
10	98.9	819	58,900	13,200	195	3,920	10,200
12	98.9	837	58,900	13,200	195	3,950	10,300
14	98.9	820	58,500	13,200	183	3,920	10,100
16	98.6	841	59,300	13,300	194	2,820	10,300
18	99.0	875	62,000	14,000	156	4,140	10,700
20	99.1	898	64,200	14,200	169	4,230	10,900
22	99.1	897	62,900	14,100	162	4,200	10,700
24	99.1	892	63,300	14,100	160	4,170	10,800

Table 6.12. Anion Analysis of PL_LAB_CL_4 Supernate

Time (hrs)	Temp. (°C)	Chloride (mg/kg soln)	Nitrate (mg/kg soln)	Nitrite (mg/kg soln)	Oxalate (mg/kg soln)	Phosphate (mg/kg soln)	Sulfate (mg/kg soln)
Initial	25.1	632	33,000	7,720	74.4	1,250	6,020
-0.85	88.1	446	32,700	7,560	72.6	2,330	5,990
0	99.2	453	32,900	7,590	84.4	2,360	5,850
1	99.1	454	32,900	7,560	81.1	1,010	5,940
2	99.0	467	33,600	7,690	81.7	2,290	6,020
4	99.0	454	33,100	7,690	92.0	2,220	6,000
12	98.9	467	33,300	7,750	71.0	2,170	5,950
14	98.9	460	33,100	7,750	68.1	1,720	5,890
16	98.6	453	32,800	7,660	64.2	2,090	5,860
18	99.0	460	33,200	7,720	69.4	2,090	5,900
20	99.1	470	33,800	7,790	66.8	2,110	6,000
22	99.1	477	34,300	7,850	64.4	2,070	6,080
24	99.1	477	34,100	7,890	58.8	1,980	6,060

Table 6.13. Anion Analysis of Slurry Samples

Sample ID	Sample Description	Chloride (mg/kg slurry)	Nitrate (mg/kg slurry)	Nitrite (mg/kg slurry)	Oxalate (mg/kg slurry)	Phosphate (mg/kg slurry)	Sulfate (mg/kg slurry)
A_LAB_CL_1_IS_SL	Test 1 Initial Washed Slurry	21.7	<87	<65	<19.7	108	<19.7
PL_LAB_CL_1_IN_SL	Test 1 Initial Slurry -1	673	50,000	11,100	2,950	3,460	8,660
A_LAB_CL_1_FS1_SL	Test 1 Final Washed Slurry -1	<18.9	<84	<62	<18.9	316	<18.9
A_LAB_CL_1_FS2_SL	Test 1 Final Washed Slurry -2	53.5	<85	<63	25.5	383	<19.3
A_LAB_CL_1_FS3_SL	Test 1 Final Washed Slurry -3	36.7	87	<63	<19.1	325	<19.1
A_LAB_CL_2_IS_SL	Test 2 Initial Washed Slurry	21.9	83	<56	66.3	157	<17.1
PL_LAB_CL_2_IN_SL	Test 2 Initial Slurry -1	427	32,400	7,390	6,270	2,180	5,950
A_LAB_CL_2_FS1_SL	Test 2 Final Washed Slurry -1	64.7	103	<62	219	561	21.4
A_LAB_CL_2_FS2_SL	Test 2 Final Washed Slurry -2	<18.4	91	<60	163	907	<18.4
A_LAB_CL_2_FS3_SL	Test 2 Final Washed Slurry -3	25.9	96	<59	156	913	<17.9
PL_LAB_CL_3_IN_SL	Test 3 Initial Slurry -1	720	52,300	11,600	3,120	1,920	9,030
A_LAB_CL_3_IS_SL	Test 3 Initial Slurry -2	<18.3	<81	<60	<18.3	<56	<18.3
A_LAB_CL_3_FS1_SL	Test 3 Final Washed Slurry -1	35.4	<84	<62	21.3	573	<19.0
A_LAB_CL_3_FS2_SL	Test 3 Final Washed Slurry -2	20.5	<85	<63	32.8	283	<19.3
A_LAB_CL_3_FS3_SL	Test 3 Final Washed Slurry -3	27.2	<84	<62	23.5	276	<19.0
PL_LAB_CL_4_IN_SL	Test 4 Initial Slurry -1	389	28,400	6,510	5,950	1,840	5,100
A_LAB_CL_4_IS_SL	Test 4 Initial Slurry -2	93.3	86	<57	103	<53	20.0
A_LAB_CL_4_FS1_SL	Test 4 Final Washed Slurry -1	89.6	90	<61	180	591	<18.7
A_LAB_CL_4_FS2_SL	Test 4 Final Washed Slurry -2	33.6	92	<60	174	598	<18.2
A_LAB_CL_4_FS3_SL	Test 4 Final Washed Slurry -3	21.8	91	<62	173	598	<18.8

Table 6.14. PEP Parallel Functional Test Density

Sample ID	Sample Description	Density (g/mL)
PL-LAB_CL_1_IN_SUP	Test 1 Initial Supernate	1.274
PL-LAB_CL_2_IN_SUP	Test 2 Initial Supernate	1.271
PL-LAB_CL_3_IN_SUP	Test 3 Initial Supernate	1.252
PL-LAB_CL_4_IN_SUP	Test 4 Initial Supernate	1.326
PL-LAB_CL_1_IN_SL	Test 1 Initial Slurry	1.304
PL-LAB_CL_2_IN_SL	Test 2 Initial Slurry	1.362
PL-LAB_CL_3_IN_SL	Test 3 Initial Slurry	1.302
PL-LAB_CL_4_IN_SL	Test 4 Initial Slurry	1.374

Table 6.15. PEP Parallel Functional Test Physical Properties of Initial Slurries

Property	PL_LAB_CL	PL_LAB_CL	PL_LAB_CL	PL_LAB_CL
	_1_IN_SL	_2_IN_SL	_3_IN_SL	_4_IN_SL
Sample Description	Test 1 Initial Slurry	Test 2 Initial Slurry	Test 3 Initial Slurry	Test 4 Initial Slurry
Bulk Density (g/mL)	1.304	1.355	1.294	1.355
Density of Cent. Solids (g/mL)	1.823	1.802	2.056	1.841
Vol% of Cent. Solids	10.0	15.0	7.50	15.0
Wt% Cent. Solids	14.0	20.0	11.9	20.4
Supernate Density (g/mL)	1.240	1.268	1.225	1.261
Wt% Total Solids	31.8	36.9	31.4	37.5
Wt% Oven Dried Solids	42.7	50.6	45.7	50.6
Wt% UDS	2.49	5.08	2.73	5.04
Wt% Dissolved Solids	30.2	33.7	29.6	34.4
Wt% Supernate Liquid	85.6	79.6	87.6	79.1

Table 6.16. PEP Parallel Functional Test Free OH Concentration

Sample ID	OH Conc. (mol/kg soln)	Sample ID	OH Conc. (mol/kg soln)
PL-LAB_CL_1_IN_SUP	3.46	PL-LAB_CL_3_IN_SUP	3.45
PL-LAB_CL_1_010C	3.50	PL-LAB_CL_3_010C	3.18
PL-LAB_CL_1_000	3.55	PL-LAB_CL_3_000	3.22
PL-LAB_CL_1_001	3.54	PL-LAB_CL_3_001	3.24
PL-LAB_CL_1_002	3.52	PL-LAB_CL_3_002	3.19
PL-LAB_CL_1_004	3.63	PL-LAB_CL_3_004	3.20
PL-LAB_CL_1_008	3.63	PL-LAB_CL_3_008	3.16
PL-LAB_CL_1_010	3.61	PL-LAB_CL_3_010	3.19
PL-LAB_CL_1_012	3.63	PL-LAB_CL_3_012	3.21
PL-LAB_CL_1_014	3.69	PL-LAB_CL_3_014	3.24
PL-LAB_CL_1_016	3.79	PL-LAB_CL_3_016	3.17
PL-LAB_CL_1_018	3.77	PL-LAB_CL_3_018	3.35
PL-LAB_CL_1_020	3.71	PL-LAB_CL_3_020	3.27
PL-LAB_CL_1_022	3.75	PL-LAB_CL_3_022	3.30
PL-LAB_CL_1_024	3.77	PL-LAB_CL_3_024	3.26
PL-LAB_CL_2_IN_SUP	4.55	PL-LAB_CL_4_IN_SUP	5.37
PL-LAB_CL_2_010C	4.77	PL-LAB_CL_4_010C	4.95
PL-LAB_CL_2_000	4.81	PL-LAB_CL_4_000	4.93
PL-LAB_CL_2_001	4.79	PL-LAB_CL_4_001	4.94
PL-LAB_CL_2_002	4.82	PL-LAB_CL_4_002	4.93
PL-LAB_CL_2_004	4.74	PL-LAB_CL_4_004	4.87
PL-LAB_CL_2_008	5.14	PL-LAB_CL_4_008	NM
PL-LAB_CL_2_010	4.74	PL-LAB_CL_4_010	NM
PL-LAB_CL_2_012	4.81	PL-LAB_CL_4_012	4.86
PL-LAB_CL_2_014	4.82	PL-LAB_CL_4_014	4.82
PL-LAB_CL_2_016	4.81	PL-LAB_CL_4_016	4.68
PL-LAB_CL_2_018	5.01	PL-LAB_CL_4_018	4.79
PL-LAB_CL_2_020	4.80	PL-LAB_CL_4_020	NM
PL-LAB_CL_2_022	4.81	PL-LAB_CL_4_022	4.77
PL-LAB_CL_2_024	4.74	PL-LAB_CL_4_024	NM

NM = not measured

6.2 PEP Test A Caustic Leach

In PEP Test A, which was conducted under Test Instruction TI-WTP-PEP-065 (TI-065), simulant stored in HLP-VSL-T22 was transferred into vessel UFP-VSL-T01A together with caustic reagent (nominally 19 M NaOH) that was injected into the feed transfer line. A sample of the feed slurry (without added caustic) was taken by grab sample from HLP-VSL-T22 for use in the laboratory-scale testing (A_LAB_CL_2). This slurry sample was taken on January 31, 2009 at 9:53.

An AFA, Dow Corning Q2-3183A, was added directly to UFP-VSL-T01A in a quantity expected to produce a nominal concentration of 350 ppm in the slurry. After this addition, another sample of slurry (composed of feed plus caustic and AFA) was taken from the inner CD sample loop at the middle-elevation port in UFP-VSL-T01A for use as feed in the laboratory-scale caustic leach tests (A_LAB_CL_1). This slurry sample was taken on January 31, 2009 at 13:30. The sample was rapidly cooled in a cold water bath to ambient temperature to minimize any further leaching reaction.

The laboratory-scale feed was stored at laboratory ambient temperature (approximately 20°C to 25°C) until it was used. The delay between the time when the feed was acquired from PEP and the time laboratory-scale testing started was about 9 days (from January 31, 2009 to February 9, 2009).

The PEP sample ID, laboratory sample ID, and the amounts of components used in these laboratory-scale tests are shown in Table 6.17.

Table 6.17. PEP Parallel Test A Matrix

PEP Sample ID	Lab Test ID	PEP Sample (g)	19M NaOH (g)	DI Water (g)
A_01AIM_002_XX_1523_CUF_4	A_LAB_CL_1	684.01	---	116.04
A_T22GM_002_XX_1508_CUF_4	A_LAB_CL_2	510.01	166.01	124.00

These tests were performed by placing the required amount of PEP simulant, NaOH, and DI water in the test vessel, attaching the lid, and heating to 57°C while stirring. At 57°C, the vessel contents were heated at a linear rate to $98 \pm 2^\circ\text{C}$ over a 4-hour and 10-minute time span. When the vessel reached $88 \pm 2^\circ\text{C}$, a sample was taken as the “-0.95 hr” target sample. At $98 \pm 2^\circ\text{C}$, a sample was taken (time 0), and the test was held for 24 hours at this temperature. Samples were taken at 1, 2, 4, 8, 10, 12, 14, 16, 20, 22, and 24 hours and immediately filtered through a 0.45- μm syringe filter. These samples were then analyzed by ICP-AES for Al, Cr, and Na concentration at SWRI, and the results are shown in Table 6.18 through Table 6.20. Slurry samples were also taken at the beginning and end of the test. Some slurry samples were washed three times with 0.01M NaOH and others were not washed. These samples were analyzed by ICP-AES for major cations at SWRI and these results are shown in Table 6.21 and Table 6.22. The samples were also analyzed by IC for anion concentrations, which are shown in Table 6.23 and Table 6.24 for the supernate and Table 6.25 for the slurries. The OH^- concentration was also measured on the supernates and the slurries and is shown in Table 6.26 and Table 6.27. The wt% solids for the two tests were also measured and are shown in Table 6.28 and Table 6.29.

Table 6.18. Supernate Al Analysis from PEP Parallel Test A Caustic Leach

Time (hrs)	Temperature (°C)	A_LAB_CL_1 (mg Al/kg soln)	A_LAB_CL_2 (mg Al/kg soln)
Initial	23.2	4,610	2,000
-0.95	88.0	6,360	6,050
0	98.2	6,550	6,140
1	98.0	6,730	6,270
2	98.0	6,580	6,430
4	98.1	7,220	5,810
8	98.1	7,790	7,210
10	98.0	7,570	7,460
12	97.4	8,060	8,320
14	97.8	8,340	9,200
16	97.9	8,330	9,190
18	98.0	8,610	9,620
20	98.0	8,800	9,960
22	97.9	8,970	10,300
24	98.1	9,600	10,600
Final	57.8	9,320	10,500

Table 6.19. Supernate Cr Analysis from PEP Parallel Test A Caustic Leach

Time (hrs)	Temperature (°C)	A_LAB_CL_1 (mg Cr/kg soln)	A_LAB_CL_2 (mg Cr/kg soln)
Initial	23.2	1.05	0.97
-0.95	88.0	1.17	1.32
0	98.2	1.31	1.65
1	98.0	1.36	2.26
2	98.0	1.41	2.09
4	98.1	1.81	2.10
8	98.1	1.45	2.87
10	98.0	1.43	3.06
12	97.4	1.30	3.47
14	97.8	1.64	3.57
16	97.9	1.58	3.55
18	98.0	1.50	3.73
20	98.0	1.51	3.80
22	97.9	1.50	3.71
24	98.1	1.53	4.06
Final	57.8	1.52	3.80

Table 6.20. Supernate Na Analysis from PEP Parallel Test A Caustic Leach

Time (hrs)	Temperature (°C)	A_LAB_CL_1 (mg Na/kg soln)	A_LAB_CL_2 (mg Na/kg soln)
Initial	23.2	118,000	109,000
-0.95	88.0	122,000	120,000
0	98.2	123,000	121,000
1	98.0	126,000	121,000
2	98.0	122,000	121,000
4	98.1	127,000	106,000
8	98.1	131,000	125,000
10	98.0	124,000	125,000
12	97.4	127,000	134,000
14	97.8	129,000	145,000
16	97.9	127,000	141,000
18	98.0	127,000	145,000
20	98.0	128,000	147,000
22	97.9	127,000	147,000
24	98.1	134,000	147,000
Final	57.8	130,000	148,000

Table 6.21. Slurry Analysis from PEP Parallel Test A Caustic Leach Test 1

	A_LAB_ CL_1_IS2_SL (mg/kg slurry)	A_LAB_ CL_1_IS3_SL (mg/kg slurry)	A_LAB_ CL_1_ISW_SL (mg/kg slurry)	A_LAB_ CL_1_FS1_SL (mg/kg slurry)	A_LAB_ CL_1_FS2_SL (mg/kg slurry)	A_LAB_ CL_1_FS3_SL (mg/kg slurry)	A_LAB_ CL_1_FS4_SL (mg/kg slurry)
	Initial Slurry-2	Initial Slurry-3	Initial Washed Slurry	Final Washed Slurry-1	Final Washed Slurry-2	Final Washed Slurry-3	Final Slurry-4
Al	9,490	9,560	17,100	10,100	10,000	9,790	11,600
Ca	92.1	91.0	280	333	329	330	97.4
Cr	1.64	1.67	1.89	1.09	1.04	1.06	1.88
Fe	2,910	2,880	9,070	10,800	10,500	10,500	3,030
Mg	62.4	61.8	190	229	227	227	64.0
Mn	623	624	1,980	2,350	2,280	2,260	660
Ni	92.6	91.8	289	353	347	345	96.3
Na	117,000	115,000	466	664	812	631	125,000
P	974	1,040	57.1	61.9	60.2	57.7	1,090
Sr	26.2	26.2	80.2	94.0	92.0	91.7	27.9
Zr	52.3	56.3	245	251	243	264	74.8

Table 6.22. Slurry Analysis from PEP Parallel Test A Caustic Leach Test 2

	A_LAB_ CL_2_IS2_SL (mg/kg slurry)	A_LAB_ CL_2_IS3_SL (mg/kg slurry)	A_LAB_ CL_2_ISW_SL (mg/kg slurry)	A_LAB_ CL_2_FS1_SL (mg/kg slurry)	A_LAB_ CL_2_FS2_SL (mg/kg slurry)	A_LAB_ CL_2_FS3_SL (mg/kg slurry)	A_LAB_ CL_2_FS4_SL (mg/kg slurry)
	Initial Slurry-2	Initial Slurry-3	Initial Washed Slurry	Final Washed Slurry-1	Final Washed Slurry-2	Final Washed Slurry-3	Final Slurry-4
Al	9,340	9,230	19,700	9,180	9,100	9,500	13,000
Ca	87.3	85.1	256	353	355	366	105
Cr	1.63	1.54	1.71	1.15	1.20	1.25	3.77
Fe	2,870	2,800	8,670	11,600	11,800	12,400	3,410
Mg	63.8	59.3	184	251	255	262	73.6
Mn	609	611	1,870	2,460	2,500	2,640	733
Ni	91.0	87.2	277	373	372	391	107
Na	115,000	113,000	626	855	873	890	139,000
P	724	680	62.0	50.2	47.5	54.9	1,230
Sr	25.9	25.8	76.3	102	102	107	31.1
Zr	56.0	54	237	273	271	282	88.8

Table 6.23. Anion Analysis of A_LAB_CL_1 Supernate

Time (hrs)	Temperature (°C)	Chloride (mg/kg soln)	Nitrate (mg/kg soln)	Nitrite (mg/kg soln)	Oxalate (mg/kg soln)	Phosphate (mg/kg soln)	Sulfate (mg/kg soln)
Initial	23.2	736	55,400	12,300	183	1,940	9,490
-0.95	88.0	763	57,100	12,600	969	3,800	9,810
0	98.2	736	54,900	12,400	1,030	3,740	9,540
1	98.0	775	58,000	12,900	1,200	3,860	9,960
2	98.0	760	56,700	12,600	1,220	3,770	9,700
4	98.1	768	57,100	12,700	1,130	3,800	9,810
8	98.1	794	59,300	13,200	1,080	3,770	10,100
10	98.0	778	57,600	12,800	1,070	3,770	9,850
12	97.4	800	58,900	13,000	1,050	3,980	9,990
14	97.8	793	59,300	13,100	1,090	3,430	10,100
16	97.9	793	58,900	13,100	932	3,620	9,960
18	98.0	817	60,700	13,400	671	3,490	10,000
20	98.0	805	59,800	13,300	882	3,890	9,920
22	97.9	797	59,300	13,200	855	3,890	9,930
24	98.1	854	63,300	14,100	946	4,510	10,500
Final	57.8	812	61,100	13,600	377	3,920	10,300

Table 6.24. Anion Analysis of A_LAB_CL_2 Supernate

Time (hrs)	Temperature (°C)	Chloride (mg/kg soln)	Nitrate (mg/kg soln)	Nitrite (mg/kg soln)	Oxalate (mg/kg soln)	Phosphate (mg/kg soln)	Sulfate (mg/kg soln)
Initial	23.2	741	51,800	12,000	323	3,710	9,330
-0.95	88.0	758	53,100	12,500	1,000	3,770	9,640
0	98.2	789	57,600	12,700	1,310	3,830	9,910
1	98.0	756	56,200	12,500	1,350	3,740	9,650
2	98.0	778	57,100	12,700	1,250	3,770	9,790
4	98.1	775	56,700	12,500	1,210	3,740	9,770
8	98.1	778	54,000	12,600	1,060	3,590	9,650
10	98.0	779	54,500	12,500	1,200	3,800	9,640
12	97.4	863	60,200	13,600	1,340	3,590	10,400
14	97.8	932	64,700	14,900	886	4,510	11,400
16	97.9	922	64,200	14,700	720	4,170	11,100
18	98.0	976	67,800	15,400	640	4,200	11,600
20	98.0	960	66,400	15,200	711	4,290	11,400
22	97.9	968	67,300	15,100	728	4,410	11,300
24	98.1	975	67,800	15,300	718	4,510	11,300
Final	57.8	965	66,900	15,300	293	4,260	11,500

Table 6.25. Anion Analysis of Slurry Samples

Sample ID	Sample Description	Chloride (mg/kg slurry)	Nitrate (mg/kg slurry)	Nitrite (mg/kg slurry)	Oxalate (mg/kg slurry)	Phosphate (mg/kg slurry)	Sulfate (mg/kg slurry)
A_LAB_CL_1_ISW_SL	Test 1 Initial Washed Slurry	<18.7	<83	<61	<18.7	<57	<18.7
A_LAB_CL_1_IS2_SL	Test 1 Initial Slurry -1	631	45,600	10,700	2,620	3,340	8,310
A_LAB_CL_1_IS3_SL	Test 1 Initial Slurry -2	636	46,100	10,700	2,590	3,190	8,370
A_LAB_CL_1_FS1_SL	Test 1 Final Washed Slurry -1	<19.3	86	<63	<19.3	129	<19.3
A_LAB_CL_1_FS2_SL	Test 1 Final Washed Slurry -2	<18.8	85	<62	<18.8	138	<18.8
A_LAB_CL_1_FS3_SL	Test 1 Final Washed Slurry -3	<19.5	89	<64	<19.5	166	<19.5
A_LAB_CL_1_FS4_SL	Test 1 Final Slurry -3	695	50,000	11,600	2,770	2,620	9,100
A_LAB_CL_2_ISW_SL	Test 2 Initial Washed Slurry	<18.8	<83	<62	<18.8	<58	<18.8
A_LAB_CL_2_IS2_SL	Test 2 Initial Slurry -1	659	46,500	10,800	2,040	1,960	8,370
A_LAB_CL_2_IS3_SL	Test 2 Initial Slurry -2	655	46,900	11,100	2,180	1,970	8,450
A_LAB_CL_2_FS1_SL	Test 2 Final Washed Slurry -1	<19.7	90	<65	<19.7	166	<19.7
A_LAB_CL_2_FS2_SL	Test 2 Final Washed Slurry -2	<19.1	87	<63	<19.1	142	<19.1
A_LAB_CL_2_FS3_SL	Test 2 Final Washed Slurry -3	<18.9	85	<62	<18.9	161	<18.9
A_LAB_CL_2_FS4_SL	Test 2 Final Slurry -3	808	57,100	13,300	2,590	3,800	10,100

Table 6.26. PEP Parallel Test A Free OH Supernate Concentration

Sample ID	OH Conc. (mol/L)	Sample ID	OH Conc. (mol/L)
A_LAB_CL_1_IN_SUP	4.06	A_LAB_CL_2_IN_SUP	3.87
A_LAB_CL_1_010C	4.05	A_LAB_CL_2_010C	3.84
A_LAB_CL_1_000	4.08	A_LAB_CL_2_000	3.70
A_LAB_CL_1_001	4.00	A_LAB_CL_2_001	3.76
A_LAB_CL_1_002	3.97	A_LAB_CL_2_002	3.62
A_LAB_CL_1_004	3.87	A_LAB_CL_2_004	3.61
A_LAB_CL_1_008	3.95	A_LAB_CL_2_008	3.76
A_LAB_CL_1_010	3.94	A_LAB_CL_2_010	4.00
A_LAB_CL_1_012	4.16	A_LAB_CL_2_012	4.49
A_LAB_CL_1_014	4.01	A_LAB_CL_2_014	4.83
A_LAB_CL_1_016	4.00	A_LAB_CL_2_016	4.81
A_LAB_CL_1_018	4.06	A_LAB_CL_2_018	4.90
A_LAB_CL_1_020	4.34	A_LAB_CL_2_020	4.81
A_LAB_CL_1_022	4.13	A_LAB_CL_2_022	4.88
A_LAB_CL_1_024	3.96	A_LAB_CL_2_024	4.75
A_LAB_CL_1_F	4.01	A_LAB_CL_2_F	4.73

Table 6.27. PEP Parallel Test A Slurry Free OH Concentration

Sample ID	Sample Description	OH Conc. (meq/g)	Sample ID	Sample Description	OH Conc. (meq/g)
A_LAB_CL_1_IS_SL	Test 1 Initial Slurry	0.0320	A_LAB_CL_3_IS_SL	Test 3 Initial Slurry	0.0283
A_LAB_CL_1_FS1_SL	Test 1 Final Washed Slurry-1	0.0417	A_LAB_CL_3_FS1_SL	Test 3 Final Washed Slurry-1	0.0474
A_LAB_CL_1_FS2_SL	Test 1 Final Washed Slurry-2	0.0483	A_LAB_CL_3_FS2_SL	Test 3 Final Washed Slurry-2	0.0424
A_LAB_CL_1_FS3_SL	Test 1 Final Washed Slurry-3	0.0425	A_LAB_CL_3_FS3_SL	Test 3 Final Washed Slurry-3	0.0399
A_LAB_CL_2_IS_SL	Test 2 Initial Slurry	0.0850	A_LAB_CL_4_IS_SL	Test 4 Initial Slurry	0.0661
A_LAB_CL_2_FS1_SL	Test 2 Final Washed Slurry-1	0.105	A_LAB_CL_4_FS1_SL	Test 4 Final Washed Slurry-1	0.111
A_LAB_CL_2_FS2_SL	Test 2 Final Washed Slurry-2	0.111	A_LAB_CL_4_FS2_SL	Test 4 Final Washed Slurry-2	0.111
A_LAB_CL_2_FS3_SL	Test 2 Final Washed Slurry-3	0.118	A_LAB_CL_4_FS3_SL	Test 4 Final Washed Slurry-3	0.110

Table 6.28. PEP Parallel Test A Physical Properties for Test 1

Property	A_LAB_CL_1_ISW_SL	A_LAB_CL_1_IS2_SL	A_LAB_CL_1_IS3_SL
Sample Description	Initial Washed Slurry	Initial Slurry-2	Initial Slurry-3
Bulk Density (g/mL)	1.044	1.325	1.304
Density of Cent. Solids (g/mL)	1.354	1.756	1.812
Vol% of Cent. Solids	16.0	10.2	10.0
Wt% Cent. Solids	20.7	13.5	13.9
Supernate Density (g/mL)	0.983	1.272	1.243
Wt% Total Solids	7.15	31.8	31.9
Wt% Oven Dried Solids	34.2	41.3	41.3
Wt% UDS	7.10	2.12	2.17
Wt% Dissolved Solids	0.056	30.4	30.4
Wt% Supernate Liquid	79.1	86.2	85.8

Table 6.28 (cont)

Property	A_LAB_CL_1_FS1_SL	A_LAB_CL_1_FS2_SL	A_LAB_CL_1_FS3_SL	A_LAB_CL_1_FS4_SL
Sample Description	Final Washed Slurry-1	Final Washed Slurry-2	Final Washed Slurry-3	Final Slurry
Bulk Density (g/mL)	1.017	1.016	1.017	1.361
Density of Cent. Solids (g/mL)	1.451	1.372	1.421	1.853
Vol% of Cent. Solids	12.0	11.8	11.8	10.4
Wt% Cent. Solids	17.1	15.9	16.4	14.2
Supernate Density (g/mL)	0.955	0.960	0.954	1.300
Wt% Total Solids	5.23	5.12	5.13	33.8
Wt% Oven Dried Solids	30.3	32.0	30.9	40.3
Wt% UDS	5.18	5.08	5.06	1.59
Wt% Dissolved Solids	0.057	0.039	0.072	32.8
Wt% Supernate Liquid	82.6	83.4	82.8	85.6

Table 6.29. PEP Parallel Test A Physical Properties for Test 2

Property	A_LAB_CL_2_ISW_SL	A_LAB_CL_2_IS2_SL	A_LAB_CL_2_IS3_SL
Sample Description	Initial Washed Slurry	Initial Slurry-2	Initial Slurry-3
Bulk Density (g/mL)	1.033	1.287	1.298
Density of Cent. Solids (g/mL)	1.439	1.553	1.651
Vol% of Cent. Solids	15.7	10.0	10.0
Wt% Cent. Solids	21.9	12.1	12.7
Supernate Density (g/mL)	0.953	1.254	1.258
Wt% Total Solids	7.70	31.3	31.1
Wt% Oven Dried Solids	35.2	40.0	41.1
Wt% UDS	7.70	1.71	2.07
Wt% Dissolved Solids	0.005	30.1	29.6
Wt% Supernate Liquid	77.8	87.7	87.2

Table 6.29 (cont)

Property	A_LAB_CL_2_ FS1_SL	A_LAB_CL_2_ FS2_SL	A_LAB_CL_2_ FS3_SL	A_LAB_CL_2_ FS4_SL
Sample Description	Final Washed Slurry-1	Final Washed Slurry-2	Final Washed Slurry-3	Final Slurry
Bulk Density (g/mL)	1.014	1.042	1.023	1.382
Density of Cent. Solids (g/mL)	1.465	1.541	1.655	2.313
Vol% of Cent. Solids	11.8	12.0	11.8	10.2
Wt% Cent. Solids	17.0	17.7	19.0	17.1
Supernate Density (g/mL)	0.950	0.971	0.935	1.274
Wt% Total Solids	5.25	5.36	5.75	38.2
Wt% Oven Dried Solids	30.6	30.2	29.9	42.1
Wt% UDS	5.20	5.35	5.68	1.27
Wt% Dissolved Solids	0.049	0.00	0.076	37.5
Wt% Supernate Liquid	82.6	82.0	80.7	82.8

6.3 PEP Test B Caustic Leach

The caustic leach process for PEP Test B was conducted under Test Instruction TI-WTP-PEP-066 (TI-066) in the PEP UFP-VSL-T02A tank and was completed as follows. Feed stored in HLP-VSL-T22 was transferred into vessel UFP-VSL-T01A. AFA was added directly to UFP-VSL-T01A in a quantity expected to produce a nominal concentration of 350 ppm in the slurry. The slurry was then transferred from the UFP-VSL-T01A feed tank to UFP-VSL-T02A, and permeate was removed from UFP-VSL-T02A through the first ultrafilter bundle to increase the solids concentration of the slurry. As permeate was removed, the volume (and level) in UFP-VSL-T02A fell, triggering the transfer of small refill batches (i.e., 11 gal) of fresh simulant from UFP-VSL-T01A. The filtering and refill process continued, leaving a target quantity of slurry at about 20-wt% UDS in the UFP-VSL-T02A vessel and filter loop. When the solids concentration process was complete, the permeate valves were closed on the filter system, caustic reagent was introduced upstream of the filter loop pumps, and more AFA was added to maintain the 350-ppm target concentration.

The caustic slurry in UFP-VSL-T02A was heated to about 71°C using the heat of dilution of the concentrated NaOH and mechanical heat from the filter loop recirculation pumps. The filter loop pumps were then turned off, and a portion of the concentrated slurry in the filter loop was flushed back into UFP-VSL-T02A before the loop was closed off from the vessel. Because the total loop volume (82 gal excluding dead volume) was significantly greater than the flush volume (~20 gal), none of the flush solution (0.01 M NaOH) is expected to have entered the vessel. After the flush, a sample of slurry was taken from the middle-low region of vessel UFP-VSL-T02A using the CD sampler for use as feed in the laboratory-scale caustic leach tests (B_LAB_CL_1 and B_LAB_CL_2 as duplicates) on March 15, 2009 at 17:15. The samples were rapidly cooled in a cold water bath to ambient temperature^(a) to minimize any further leaching reaction.

(a) According to an interview with the lead sample handler, for one of the Test B laboratory-scale 1-L samples, rapid cooling proceeded only for about 1 hour before it had to be moved from the cold-water bath to make room in the bath for analytical PEP samples. Cooling of the laboratory-scale 1-L sample was continued by running it under cold water in the sink.

The laboratory-scale feed was stored at laboratory ambient temperature until it was used. The delay between the time when the feed was acquired from PEP and the time laboratory-scale testing started was about 4 days for Test B (from March 15, 2009 to March 19, 2009).

The PEP sample ID, laboratory sample ID, and the amount of water used in the parallel laboratory-scale tests are shown in Table 6.30.

Table 6.30. PEP Parallel Test B Matrix

PEP Sample ID	Laboratory Test ID	PEP Sample (g)	DI Water (g)
B_02AML_016_XX_4469_CUF_4	B_LAB_CL_1	669.02	131.00
B_02AML_016_XX_4469_CUF_4	B_LAB_CL_2	669.01	131.02

These tests were performed by placing the required amount of PEP simulant and DI water in the test vessel, attaching the lid, and heating to 71°C while stirring. At 71°C, the vessel contents were heated at a linear rate to 98 ± 2°C over a 2.6-hour time span. When the vessel reached 88 ± 2°C, a sample was taken as the “-0.95 hr” sample. At 98 ± 2°C, the time zero (0 hr) sample was taken, and the test was held for 24 hours at this temperature. Samples were taken at 1, 2, 4, 8, 10, 12, 14, 16, 20, 22, and 24 hours and immediately filtered through a 0.45-µm syringe filter. These samples were then analyzed by ICP-AES for Al, Cr, and Na concentration at SWRI, and the results are shown in Table 6.31 through Table 6.33. Slurry samples were also taken at the beginning and end of the test. Some slurry samples were washed three times with 0.01M NaOH and others were not washed. These samples were analyzed by ICP-AES for major cations at SWRI and these results are shown in Table 6.34 through Table 6.35. The samples were also analyzed by IC for anion concentrations, which are shown in Table 6.36 and Table 6.37 for the supernate and Table 6.38 for the slurries. The OH⁻ concentration, which was also measured on the supernates, is shown in Table 6.39. The wt% solids of the slurry (both washed and unwashed) for each test were measured and are shown in Table 6.40 and Table 6.41.

Table 6.31. Supernate Al Analysis from PEP Parallel Test B Caustic Leach

Time (hrs)	Temperature (°C)	B-LAB_CL_1 (mg Al/kg soln)	B-LAB_CL_2 (mg Al/kg soln)
Initial	23.4	12,400	12,200
-0.95	88.2	12,300	12,600
0	98.2	13,000	12,200
1	98.0	13,700	13,300
2	98.0	13,600	13,400
4	98.0	14,500	14,500
8	98.0	15,800	16,300
10	97.7	16,100	16,100
12	98.0	16,900	16,800
14	98.0	17,200	17,300
16	98.2	17,700	18,200
18	97.9	18,200	19,000
21	98.0	18,900	19,300
24	98.1	19,800	19,800

Table 6.32. Supernate Cr Analysis from PEP Parallel Test B Caustic Leach

Time (hrs)	Temperature (°C)	B-LAB_CL_1 (mg Cr/kg soln)	B-LAB_CL_2 (mg Cr/kg soln)
Initial	23.4	2.10	2.26
-0.95	88.2	2.36	2.61
0	98.2	3.03	2.80
1	98.0	3.48	3.28
2	98.0	3.41	3.39
4	98.0	3.77	3.84
8	98.0	3.92	3.86
10	97.7	4.30	4.01
12	98.0	4.21	4.05
14	98.0	4.20	4.28
16	98.2	4.40	4.36
18	97.9	4.46	4.49
21	98.0	4.58	4.44
24	98.1	4.71	4.72

Table 6.33. Supernate Na Analysis from PEP Parallel Test B Caustic Leach

Time (hrs)	Temperature (°C)	B-LAB_CL_1 (mg Na/kg soln)	B-LAB_CL_2 (mg Na/kg soln)
Initial	23.4	133,000	135,000
-0.95	88.2	134,000	137,000
0	98.2	135,000	138,000
1	98.0	138,000	135,000
2	98.0	136,000	137,000
4	98.0	137,000	143,000
8	98.0	138,000	144,000
10	97.7	138,000	141,000
12	98.0	138,000	141,000
14	98.0	138,000	139,000
16	98.2	138,000	142,000
18	97.9	137,000	142,000
21	98.0	139,000	142,000
24	98.1	140,000	144,000

Table 6.34. Slurry Analysis from PEP Parallel Test B Caustic Leach Test 1

	B_LAB_CL_1_SS1_SL (mg/kg slurry)	B_LAB_CL_1_SS2_SL (mg/kg slurry)	B_LAB_CL_1_SS3_SL (mg/kg slurry)	B_LAB_CL_1_FS1_SL (mg/kg slurry)	B_LAB_CL_1_FS2_SL (mg/kg slurry)	B_LAB_CL_1_FS3_SL (mg/kg slurry)
	Initial Washed Slurry-1	Initial Washed Slurry-2	Initial Slurry	Final Washed Slurry-1	Final Washed Slurry-2	Final Slurry
Al	37,800	39,400	26,800	29,500	27,700	28,300
Ca	758	768	286	905	888	308
Cr	29.3	22	16	31.8	31.8	15.5
Fe	23,500	24,200	8,960	28,100	27,900	9,660
Mg	454	469	169	534	525	182
Mn	5,260	5,310	1,940	6,370	5,950	2,090
Ni	760	784	281	897	887	304
Na	2,250	1,790	132,000	2,610	2,850	142,000
P	116	125	742	152	155	661
Sr	209	213	80.6	250	244	87.2
Zr	696	697	242	811	824	184

Table 6.35. Slurry Analysis from PEP Parallel Test B Caustic Leach Test 2

	B_LAB_CL_2_SS1_SL (mg/kg slurry)	B_LAB_CL_2_SS2_SL (mg/kg slurry)	B_LAB_CL_2_SS3_SL (mg/kg slurry)	B_LAB_CL_2_FS1_SL (mg/kg slurry)	B_LAB_CL_2_FS2_SL (mg/kg slurry)	B_LAB_CL_2_FS3_SL (mg/kg slurry)
	Initial Washed Slurry-1	Initial Washed Slurry-2	Initial Slurry	Final Washed Slurry-1	Final Washed Slurry-2	Final Slurry
Al	36,700	39,500	25,700	26,800	26,300	28,700
Ca	763	749	285	842	846	312
Cr	25.1	24.5	14.5	31.1	33.6	15.9
Fe	23,900	23,500	8,850	26,300	26,400	9,730
Mg	461	451	169	502	500	186
Mn	5,330	5,360	1,910	5,700	5,600	2,120
Ni	771	758	276	842	842	307
Na	1,820	1,760	130,000	2,760	2,930	143,000
P	125	126	738	163	162	777
Sr	214	212	79.6	231	232	86.6
Zr	684	688	251	765	777	255

Table 6.36. Anion Analysis of B_LAB_CL_1 Supernate

Time (hrs)	Temperature (°C)	Chloride (mg/kg soln)	Nitrate (mg/kg soln)	Nitrite (mg/kg soln)	Oxalate (mg/kg soln)	Phosphate (mg/kg soln)	Sulfate (mg/kg soln)
Initial	23.4	414	34,000	8,150	77.2	2,080	6,590
-0.95	88.2	409	34,100	8,080	271	2,120	6,540
0	98.2	422	34,500	8,150	490	2,280	6,690
1	98.0	429	35,100	8,350	466	2,300	6,780
2	98.0	418	34,500	8,210	466	2,270	6,690
4	98.0	427	35,000	8,350	458	2,240	6,760
8	98.0	428	34,700	8,310	473	2,190	6,670
10	97.7	429	35,400	8,350	321	2,240	6,770
12	98.0	432	35,500	8,440	289	2,120	6,730
14	98.0	426	35,000	8,310	281	2,050	6,660
16	98.2	430	35,800	8,480	138	2,080	6,810
18	97.9	438	35,900	8,480	158	2,130	6,860
21	98.0	438	36,300	8,480	119	1,930	6,800
24	98.1	443	36,200	8,640	113	2,000	6,780

Table 6.37. Anion Analysis of B_LAB_CL_2 Supernate

Time (hrs)	Temperature (°C)	Chloride (mg/kg soln)	Nitrate (mg/kg soln)	Nitrite (mg/kg soln)	Oxalate (mg/kg soln)	Phosphate (mg/kg soln)	Sulfate (mg/kg soln)
Initial	23.4	408	33,400	7,980	69.7	1,700	6,560
-0.95	88.2	419	34,100	8,080	283	2,150	6,530
0	98.2	426	35,000	8,450	448	2,150	6,600
1	98.0	422	34,500	8,210	457	2,300	6,700
2	98.0	418	34,500	8,210	388	2,250	6,630
4	98.0	456	37,500	8,670	437	2,270	7,020
8	98.0	455	36,900	8,670	443	2,180	6,940
10	97.7	435	35,500	8,480	315	2,140	6,810
12	98.0	439	35,200	8,310	301	2,050	6,670
14	98.0	432	34,900	8,380	291	2,030	6,670
16	98.2	432	35,400	8,380	192	2,000	6,700
18	97.9	433	35,500	8,380	163	1,900	6,650
21	98.0	439	36,000	8,510	207	1,900	6,760
24	98.1	438	35,900	8,640	141	2,020	6,690

Table 6.38. Anion Analysis of Slurry Samples for Test B Caustic Leach

Sample ID	Sample Description	Chloride (mg/kg slurry)	Nitrate (mg/kg slurry)	Nitrite (mg/kg slurry)	Oxalate (mg/kg slurry)	Phosphate (mg/kg slurry)	Sulfate (mg/kg slurry)
B_LAB_CL_1_SS1_SL	Test 1 Initial Washed Slurry -1	<18.6	137	<61	106	101	28.2
B_LAB_CL_1_SS2_SL	Test 1 Initial Washed Slurry -2	<19.0	107	<62	68.6	101	23.3
B_LAB_CL_1_SS3_SL	Test 1 Initial Slurry -3	334	28,000	7,130	7,860	1,980	5,580
B_LAB_CL_1_FS1_SL	Test 1 Final Washed Slurry -1	<19.8	148	<65	224	186	43.2
B_LAB_CL_1_FS2_SL	Test 1 Final Washed Slurry -2	<19.4	139	<64	1,040	169	30.8
B_LAB_CL_1_FS3_SL	Test 1 Final Slurry -3	369	30,500	7,660	8,450	1,940	6,010
B_LAB_CL_2_SS1_SL	Test 1 Initial Washed Slurry -1	<19.3	96	<63	57.1	108	<19.3
B_LAB_CL_2_SS2_SL	Test 1 Initial Washed Slurry -2	<18.6	98	<61	61.7	105	<18.6
B_LAB_CL_2_SS3_SL	Test 1 Initial Slurry -3	342	28,200	7,100	8,050	2,040	5,520
B_LAB_CL_2_FS1_SL	Test 2 Final Washed Slurry -1	<18.8	162	<62	650	184	52.6
B_LAB_CL_2_FS2_SL	Test 2 Final Washed Slurry -2	<19.3	188	64	676	207	68.2
B_LAB_CL_2_FS3_SL	Test 2 Final Slurry -3	371	30,600	7,660	8,700	1,640	6,070

Table 6.39. PEP Parallel Test B Free OH Concentration

Sample ID	OH Conc. (mol/L)	Sample ID	OH Conc. (mol/L)
B_LAB_CL_1_000	5.93	B_LAB_CL_2_000	5.42
B_LAB_CL_1_001	5.67	B_LAB_CL_2_001	5.47
B_LAB_CL_1_002	5.70	B_LAB_CL_2_002	5.48
B_LAB_CL_1_004	5.50	B_LAB_CL_2_004	5.46
B_LAB_CL_1_008	5.62	B_LAB_CL_2_008	5.67
B_LAB_CL_1_010	5.59	B_LAB_CL_2_010	5.53
B_LAB_CL_1_012	5.43	B_LAB_CL_2_012	5.58
B_LAB_CL_1_014	5.65	B_LAB_CL_2_014	5.39
B_LAB_CL_1_016	5.80	B_LAB_CL_2_016	5.67
B_LAB_CL_1_018	5.58	B_LAB_CL_2_018	5.59
B_LAB_CL_1_021	4.67	B_LAB_CL_2_021	5.47
B_LAB_CL_1_024	5.62	B_LAB_CL_2_024	5.46

Table 6.40. PEP Parallel Test B Physical Properties for Test 1

Property	B_LAB_CL_1_SS1_SL	B_LAB_CL_1_SS2_SL	B_LAB_CL_1_SS3_SL
Sample Description	Initial Washed Slurry-1	Initial Washed Slurry-2	Initial Slurry
Bulk Density (g/mL)	1.146	1.103	1.370
Density of Cent. Solids (g/mL)	1.546	1.568	1.812
Vol% of Cent. Solids	26.5	25.5	18.0
Wt% Cent. Solids	35.8	36.2	23.8
Supernate Density (g/mL)	0.989	0.934	1.270
Wt% Total Solids	15.8	16.0	38.0
Wt% Oven Dried Solids	43.5	43.7	50.2
Wt% UDS	15.5	15.8	5.74
Wt% Dissolved Solids	0.373	0.225	34.3
Wt% Supernate Liquid	63.4	63.1	76.0

Table 6.40 (cont)

Property	B_LAB_CL_1_FS1_SL	B_LAB_CL_1_FS2_SL	B_LAB_CL_1_FS3_SL
Sample Description	Final Washed Slurry-1	Final Washed Slurry-2	Final Slurry
Bulk Density (g/mL)	1.090	1.113	1.426
Density of Cent. Solids (g/mL)	1.399	1.475	1.995
Vol% of Cent. Solids	24.5	23.4	18.4
Wt% Cent. Solids	31.4	31.0	25.7
Supernate Density (g/mL)	0.984	0.996	1.296
Wt% Total Solids	12.6	11.6	40.3
Wt% Oven Dried Solids	39.5	36.3	49.4
Wt% UDS	12.3	11.2	5.01
Wt% Dissolved Solids	0.341	0.488	37.2
Wt% Supernate Liquid	68.2	68.5	74.2

Table 6.41. PEP Parallel Test B Physical Properties for Test 2

Property	B_LAB_CL_2_SS1_SL	B_LAB_CL_2_SS2_SL	B_LAB_CL_2_SS3_SL
Sample Description	Initial Washed Slurry-1	Initial Washed Slurry-2	Initial Slurry
Bulk Density (g/mL)	1.150	1.148	1.402
Density of Cent. Solids (g/mL)	1.559	1.532	1.855
Vol% of Cent. Solids	26.5	26.5	18.4
Wt% Cent. Solids	36.0	35.4	24.3
Supernate Density (g/mL)	0.994	1.002	1.298
Wt% Total Solids	15.7	15.8	37.7
Wt% Oven Dried Solids	43.5	44.2	49.4
Wt% UDS	15.6	15.6	5.67
Wt% Dissolved Solids	0.120	0.180	34.0
Wt% Supernate Liquid	63.5	64.1	75.6

Table 6.41 (cont)

Property	B_LAB_CL_2_FS1_SL	B_LAB_CL_2_FS2_SL	B_LAB_CL_2_FS3_SL
Sample Description	Final Washed Slurry-1	Final Washed Slurry-2	Final Slurry
Bulk Density (g/mL)	1.100	1.104	1.430
Density of Cent. Solids (g/mL)	1.408	1.467	2.065
Vol% of Cent. Solids	25.0	23.4	18.4
Wt% Cent. Solids	32.0	31.1	26.5
Supernate Density (g/mL)	0.991	0.985	1.284
Wt% Total Solids	12.7	12.1	40.2
Wt% Oven Dried Solids	38.9	38.0	48.6
Wt% UDS	12.4	11.7	4.80
Wt% Dissolved Solids	0.423	0.437	37.2
Wt% Supernate Liquid	67.5	68.3	73.3

6.4 PEP Test D Caustic Leach

The caustic leach process for PEP Test D was conducted under Test Instruction TI-WTP-PEP-082 (TI-082) in the PEP UFP-VSL-T02A tank and was completed as follows. Feed stored in HLP-VSL-T22 was transferred into vessel UFP-VSL-T01A. AFA was added directly to UFP-VSL-T01A in a quantity expected to produce a nominal concentration of 350 ppm in the slurry. The slurry was then transferred from the UFP-VSL-T01A feed tank to UFP-VSL-T02A, and permeate was removed from UFP-VSL-T02A through the first ultrafilter bundle to increase the solids concentration of the slurry. As permeate was removed, the volume (and level) in UFP-VSL-T02A fell, triggering the transfer of small refill batches (i.e., 11 gal) of fresh simulant from UFP-VSL-T01A. The filtering and refill process continued, leaving a target quantity of slurry at about 20-wt% UDS in the UFP-VSL-T02A vessel and filter loop. When the solids concentration process was complete, the permeate valves were closed on the filter system, and caustic reagent was introduced upstream of the filter loop pumps.

The caustic slurry in UFP-VSL-T02A was heated to about 70°C using the heat of dilution of the concentrated NaOH and mechanical heat from the filter loop recirculation pumps. A sample of slurry was taken from the middle-low region of vessel UFP-VSL-T02A using the CD sampler for use as feed in the

laboratory-scale caustic leach tests (D_LAB_CL_1 and D_LAB_CL_2 as duplicates) on March 27, 2009 at 16:07. The sample was rapidly cooled in a cold water bath to ambient temperature to minimize any further leaching reaction.

The laboratory-scale feed was stored at laboratory ambient temperature (approximately 20°C to 25°C) until it was used. The delay between the time when the feed was acquired from PEP and the time laboratory-scale testing started was about 12 days for Test D (from March 27, 2009, to April 8, 2009).

The PEP sample ID, laboratory sample ID, and the amount of water used in the parallel laboratory-scale tests are shown in Table 6.42.

Table 6.42. PEP Parallel Test D Matrix

PEP Sample ID	Test ID	PEP Sample (g)	DI Water (g)
D_02AML_07A_XX_5198_CUF_4	D_LAB_CL_1	685.02	115.01
D_02AML_07A_XX_5198_CUF_4	D_LAB_CL_2	685.01	115.01

These tests were performed by placing the required amount of PEP simulant and DI water in the test vessel, attaching the lid, and heating to 70°C while stirring. At 70°C, the vessel contents were heated at a linear rate to $85 \pm 2^\circ\text{C}$ over a 1 hour and 35 minute time span. When the vessel reached $75 \pm 2^\circ\text{C}$, a sample was taken as the -1.53 hr sample. At $85 \pm 2^\circ\text{C}$, the time zero (0 hr) sample was taken, and the test was held for 24 hours at this temperature. Samples were taken at 1, 2, 4, 8, 10, 12, 14, 16, 18, and 24 hours and immediately filtered through a 0.45- μm syringe filter. These samples were then analyzed by ICP-AES for Al, Cr, and Na concentration at SWRI, and the results are shown in Table 6.43 through Table 6.45. Slurry samples were also taken at the beginning and end of the test. Some slurry samples were washed three times with 0.01M NaOH and others were not washed. These results are shown in Table 6.46 and Table 6.47. The samples were analyzed by IC for anion concentrations, which are shown in Table 6.48 and Table 6.49 for the supernate and Table 6.50 for the slurries. The OH⁻ concentration was also measured on the supernates and is shown in Table 6.51. The wt% UDS along with other physical properties were measured on the slurries (both washed and unwashed) and are shown in Table 6.52 and Table 6.53.

Table 6.43. Supernate Al Analysis from PEP Parallel Test D Caustic Leach

Time (hrs)	Temperature (°C)	D_LAB_CL_1 (mg Al/kg soln)	D_LAB_CL_2 (mg Al/kg soln)
Initial	23.8	9,340	10,400
-1.53	71.8	10,400	10,700
0	85.4	10,200	10,500
1	85.1	10,600	10,900
2	85.0	10,700	10,900
4	85.1	11,500	11,500
8	85.0	12,500	11,700
10	85.0	12,700	12,500
12	84.9	13,000	13,400
14	85.0	13,600	13,700
16	85.0	13,900	14,000
18	85.0	14,400	14,600
20	84.9	14,200	14,300
24	85.0	14,900	15,000
Final	31.6	14,700	14,200

Table 6.44. Supernate Cr Analysis from PEP Parallel Test D Caustic Leach

Time (hrs)	Temperature (°C)	D_LAB_CL_1 (mg Cr/kg soln)	D_LAB_CL_2 (mg Cr/kg soln)
Initial	23.8	169	179
-1.53	71.8	195	199
0	85.4	307	307
1	85.1	368	362
2	85.0	419	414
4	85.1	497	492
8	85.0	591	552
10	85.0	614	615
12	84.9	650	654
14	85.0	685	686
16	85.0	719	721
18	85.0	757	758
20	84.9	741	771
24	85.0	803	821
Final	31.6	787	787

Table 6.45. Supernate Na Analysis from PEP Parallel Test D Caustic Leach

Time (hrs)	Temperature (°C)	D_LAB_CL_1 (mg Na/kg soln)	D_LAB_CL_2 (mg Na/kg soln)
Initial	23.8	154,000	161,000
-1.53	71.8	162,000	166,000
0	85.4	166,000	166,000
1	85.1	166,000	166,000
2	85.0	168,000	166,000
4	85.1	172,000	174,000
8	85.0	179,000	164,000
10	85.0	175,000	172,000
12	84.9	174,000	175,000
14	85.0	176,000	174,000
16	85.0	177,000	177,000
18	85.0	179,000	176,000
20	84.9	174,000	168,000
24	85.0	171,000	168,000
Final	31.6	165,000	162,000

Table 6.46. Slurry Analysis from PEP Parallel Test D Caustic Leach Test 1

	D_LAB_CL_1_IS_SL (mg/kg slurry)	D_LAB_CL_1_ISW1_SL (mg/kg slurry)	D_LAB_CL_1_ISW2_SL (mg/kg slurry)	D_LAB_CL_1_FS1_SL (mg/kg slurry)	D_LAB_CL_1_FSW1_SL (mg/kg slurry)	D_LAB_CL_1_FSW2_SL (mg/kg slurry)
	Initial Slurry	Initial Washed Slurry-1	Initial Washed Slurry-2	Final Slurry	Final Washed Slurry-1	Final Washed Slurry-2
Al	22,100	41,000	39,100	25,200	33,900	30,000
Ca	237	391	513	249	630	627
Cr	1,260	1,490	2,200	1,360	1,470	1,500
Fe	7,670	11,200	16,000	8,160	20,300	20,800
Mg	146	257	323	154	385	389
Mn	1,570	3,770	4,110	1,550	4,000	3,920
Ni	241	398	526	256	639	655
Na	150,000	1,310	1,470	162,000	2,420	4,390
P	557	26.3	39.1	588	41.0	47.8
Sr	69.2	102	143	74.0	177	180
Zr	178	313	436	190	552	560

Table 6.47. Slurry Analysis from PEP Parallel Test D Caustic Leach Test 2

	D_LAB_ CL_2_IS_SL (mg/kg slurry)	D_LAB_ CL_2_ISW1_SL (mg/kg slurry)	D_LAB_ CL_2_ISW2_SL (mg/kg slurry)	D_LAB_ CL_2_FS1_SL (mg/kg slurry)	D_LAB_ CL_2_FSW1_SL (mg/kg slurry)	D_LAB_ CL_2_FSW2_SL (mg/kg slurry)
	Initial Slurry	Initial Washed Slurry-1	Initial Washed Slurry-2	Final Slurry	Final Washed Slurry-1	Final Washed Slurry-2
Al	22,100	36,900	39,200	24,500	29,100	31,100
Ca	235	376	532	247	639	635
Cr	1,270	1,440	2,210	1,340	1,500	1,520
Fe	7,730	10,800	16,100	8,010	21,200	21,400
Mg	144	247	335	154	405	395
Mn	1,590	3,430	4,120	1,580	3,910	4,000
Ni	243	379	530	251	665	674
Na	149,000	1,280	1,510	156,000	2,680	3,850
P	538	24.4	34.2	576	41.9	51.5
Sr	68.7	98.1	146	70.8	184	187
Zr	175	297	445	191	573	576

Table 6.48. Anion Analysis of D_LAB_CL_1 Supernate

Time (hrs)	Temperature (°C)	Chloride (mg/kg soln)	Nitrate (mg/kg soln)	Nitrite (mg/kg soln)	Oxalate (mg/kg soln)	Phosphate (mg/kg soln)	Sulfate (mg/kg soln)
Initial	23.8	328	26,000	6,340	31.4	1,650	2,740
-1.53	71.8	394	32,600	7,790	99.2	2,220	3,910
0	85.4	332	27,300	6,600	174	1,860	3,640
1	85.1	337	27,600	6,600	175	1,890	3,590
2	85.0	340	27,300	6,740	159	1,890	3,650
4	85.1	349	28,100	6,770	184	1,900	3,570
8	85.0	373	29,900	7,160	174	2,030	3,510
10	85.0	359	29,100	7,100	169	2,040	3,470
12	84.9	362	29,000	7,100	123	2,030	3,320
14	85.0	351	28,700	7,060	121	2,020	3,220
16	85.0	372	29,900	7,200	93.6	2,090	3,120
18	85.0	370	30,200	7,260	70.7	2,070	2,980
20	84.9	384	31,100	7,430	37.0	2,140	2,810
24	85.0	379	30,600	7,430	75.4	2,060	2,920
Final	31.6	389	31,000	7,390	14.9	1,580	2,310

Table 6.49. Anion Analysis of D_LAB_CL_2 Supernate

Time (hrs)	Temperature (°C)	Chloride (mg/kg soln)	Nitrate (mg/kg soln)	Nitrite (mg/kg soln)	Oxalate (mg/kg soln)	Phosphate (mg/kg soln)	Sulfate (mg/kg soln)
Initial	23.8	384	31,200	7,460	34.6	1,930	3,200
-1.53	71.8	403	31,500	7,790	146	2,230	4,070
0	85.4	331	26,900	6,670	190	1,900	3,790
1	85.1	349	27,600	6,670	193	1,900	3,710
2	85.0	340	27,500	6,700	158	1,930	3,670
4	85.1	355	27,900	6,770	208	1,940	3,750
8	85.0	342	27,700	6,770	177	1,940	3,650
10	85.0	357	28,600	7,030	131	2,010	3,700
12	84.9	478	29,100	6,930	97.4	2,060	3,490
14	85.0	373	29,600	7,130	130	2,040	3,610
16	85.0	359	28,700	7,030	88.0	2,000	3,560
18	85.0	358	29,000	7,100	92.9	2,020	3,520
20	84.9	371	29,500	7,200	34.3	2,050	3,240
24	85.0	359	29,000	6,930	88.2	1,980	3,230
Final	31.6	318	25,000	5,950	16.3	1,280	2,220

Table 6.50. Anion Analysis of Slurry Samples for Test D Caustic Leach

Sample ID	Sample Description	Chloride (mg/kg slurry)	Nitrate (mg/kg slurry)	Nitrite (mg/kg slurry)	Oxalate (mg/kg slurry)	Phosphate (mg/kg slurry)	Sulfate (mg/kg slurry)
D_LAB_CL_1_IS_SL	Test 1 Initial Slurry	283	22,400	5,520	6,410	1,550	4,440
D_LAB_CL_1_ISW1_SL	Test 1 Initial Washed Slurry -1	<18.6	100	<61	150	<57	47.4
D_LAB_CL_1_ISW2_SL	Test 1 Initial Washed Slurry -2	<19.1	95	<63	157	<59	<19.1
D_LAB_CL_1_FS1_SL	Test 1 Final Slurry -1	299	23,700	5,910	6,510	1,610	4,660
D_LAB_CL_1_FSW1_SL	Test 1 Final Washed Slurry -2	<19.9	164	<65	392	<61	190
D_LAB_CL_1_FSW2_SL	Test 1 Final Washed Slurry -3	<19.3	366	113	1,230	92	365
D_LAB_CL_2_IS_SL	Test 2 Initial Slurry	284	22,300	5,520	6,480	1,580	4,480
D_LAB_CL_2_ISW1_SL	Test 2 Initial Washed Slurry -1	<19.4	103	<64	166	<59	28.3
D_LAB_CL_2_ISW2_SL	Test 2 Initial Washed Slurry -2	<19.4	99	<64	158	<59	<19.4
D_LAB_CL_2_FS1_SL	Test 2 Final Slurry -1	292	23,100	5,750	6,360	1,560	4,460
D_LAB_CL_2_FSW1_SL	Test 2 Final Washed Slurry -2	<19.9	183	67	572	67	152
D_LAB_CL_2_FSW2_SL	Test 2 Final Washed Slurry -3	<19.1	331	101	1,090	89	260

Table 6.51. PEP Parallel Test D Free OH Concentration

Sample ID	OH Conc. (mol/L)	Sample ID	OH Conc. (mol/L)
D_LAB_CL_1_IN_SUP	8.08	D_LAB_CL_2_IN_SUP	7.91
D_LAB_CL_1_010C	7.86	D_LAB_CL_2_010C	8.06
D_LAB_CL_1_000	8.11	D_LAB_CL_2_000	8.12
D_LAB_CL_1_001	8.03	D_LAB_CL_2_001	8.00
D_LAB_CL_1_002	8.13	D_LAB_CL_2_002	8.09
D_LAB_CL_1_004	7.99	D_LAB_CL_2_004	8.18
D_LAB_CL_1_008	8.17	D_LAB_CL_2_008	7.94
D_LAB_CL_1_010	8.34	D_LAB_CL_2_010	8.02
D_LAB_CL_1_012	8.35	D_LAB_CL_2_012	8.12
D_LAB_CL_1_014	8.41	D_LAB_CL_2_014	8.05
D_LAB_CL_1_016	8.13	D_LAB_CL_2_016	8.11
D_LAB_CL_1_018	8.36	D_LAB_CL_2_018	8.06
D_LAB_CL_1_020	8.42	D_LAB_CL_2_020	7.92
D_LAB_CL_1_024	8.21	D_LAB_CL_2_024	8.20
D_LAB_CL_1_F	8.45	D_LAB_CL_2_F	8.54

Table 6.52. PEP Parallel Test D Physical Properties for Test 1

Property	D_LAB_CL_1_IS_SL	D_LAB_CL_1_ISW1_SL	D_LAB_CL_1_ISW2_SL
Sample Description	Initial Slurry	Initial Washed Slurry-1	Initial Washed Slurry-2
Bulk Density (g/mL)	1.424	1.086	1.105
Density of Cent. Solids (g/mL)	1.729	1.519	1.447
Vol% of Cent. Solids	20.4	21.3	26.0
Wt% Cent. Solids	24.8	29.7	34.1
Supernate Density (g/mL)	1.346	0.965	0.980
Wt% Total Solids	41.5	13.7	14.4
Wt% Oven Dried Solids	50.7	46.2	42.3
Wt% UDS	4.91	13.7	14.4
Wt% Dissolved Solids	38.5	0	0.028
Wt% Supernate Liquid	75.2	70.0	65.7

Table 6.52 (cont.)

Property	D_LAB_CL_1_FSI_SL	D_LAB_CL_1_FSW1_SL	D_LAB_CL_1_FSW2_SL
Sample Description	Final Slurry	Final Washed Slurry-1	Final Washed Slurry-2
Bulk Density (g/mL)	1.408	1.081	1.090
Density of Cent. Solids (g/mL)	1.742	1.295	1.344
Vol% of Cent. Solids	22.0	27.1	25.0
Wt% Cent. Solids	27.2	32.5	30.8
Supernate Density (g/mL)	1.314	0.998	1.001
Wt% Total Solids	43.8	12.7	11.8
Wt% Oven Dried Solids	51.9	38.3	36.2
Wt% UDS	5.13	12.4	11.0
Wt% Dissolved Solids	40.8	0.358	0.944
Wt% Supernate Liquid	72.8	67.3	68.9

Table 6.53. PEP Parallel Test D Physical Properties for Test 2

Property	D_LAB_CL_2_IS_SL	D_LAB_CL_2_ISW1_SL	D_LAB_CL_2_ISW2_SL
Sample Description	Initial Slurry	Initial Washed Slurry-1	Initial Washed Slurry-2
Bulk Density (g/mL)	1.425	1.101	1.130
Density of Cent. Solids (g/mL)	1.697	1.559	1.379
Vol% of Cent. Solids	20.4	20.4	28.6
Wt% Cent. Solids	24.3	28.9	34.9
Supernate Density (g/mL)	1.355	0.979	1.023
Wt% Total Solids	41.6	12.9	14.6
Wt% Oven Dried Solids	51.8	44.8	41.8
Wt% UDS	5.30	13.0	14.6
Wt% Dissolved Solids	38.3	0	0.025
Wt% Supernate Liquid	75.7	70.8	64.6

Table 6.53 (cont.)

Property	D_LAB_CL_2_FS1_SL	D_LAB_CL_2_FSW1_SL	D_LAB_CL_2_FSW2_SL
Sample Description	Final Slurry	Final Washed Slurry-1	Final Washed Slurry-2
Bulk Density (g/mL)	1.442	1.110	1.102
Density of Cent. Solids (g/mL)	1.863	1.392	1.305
Vol% of Cent. Solids	18.4	25.5	27.9
Wt% Cent. Solids	23.7	32.0	33.0
Supernate Density (g/mL)	1.347	1.009	1.021
Wt% Total Solids	42.5	12.2	12.9
Wt% Oven Dried Solids	50.8	37.2	37.4
Wt% UDS	4.27	11.8	12.2
Wt% Dissolved Solids	40.0	0.385	0.809
Wt% Supernate Liquid	76.2	67.7	66.8

6.5 PEP Tests A, B, and D Oxidative Leach Parallel Laboratory Tests

For wastes that have significantly high chromium content, the caustic leaching and slurry dewatering are followed by adding sodium permanganate to UFP-VSL-T02A, and the slurry is subjected to oxidative leaching at nominally ambient temperature. The purpose of the oxidative leaching is to selectively oxidize the poorly alkaline-soluble Cr(III) believed to be the insoluble form in Hanford tank sludge to the much more alkaline-soluble Cr(VI), e.g., chromate.

The objectives of these tests were to provide data to support the development of scale factors between laboratory process measurements and those of PEP related to oxidative leaching. The testing included the following tests with simulated Hanford tank waste:

- Integrated Test A: Demonstrated integrated processing when caustic leaching (98°C) is performed in UFP-VSL-00001A/B (PEP equivalent: UFP-VSL-T01A&B) with the Cr simulant component added after the post-caustic-leach washing step.

- Integrated Test B: Demonstrated integrated processing when the caustic leaching (98°C) was performed in UFP-VSL-00002A (PEP equivalent: UFP-VSL-T02A) with the Cr simulant component added after the post-caustic-leach washing step.
- Integrated Test D: Demonstrated integrated processing when the caustic leaching is performed at a lower temperature (85°C) in UFP-VSL-00002A (PEP equivalent: UFP-VSL-T02A) and with the Cr simulant component added to the initial batch of simulant.

Following the post-caustic-leach wash, the oxidative leach process in PEP Tests A and B proceeded according to TI-065 and TI-066, respectively. First, chromium oxyhydroxide slurry was added in-line. The slurry was then dewatered, and the slurry was washed to reduce the OH⁻ to a targeted concentration of ≈ 0.25 M. During these wash steps, AFA was added periodically. Following completion of the Cr-containing slurry washing, a sample of slurry was taken for use in the laboratory-scale oxidative leach tests (A_LAB_OL_1 and B_LAB_OL_2).

PEP Test D was performed slightly differently in that the CrOOH component was an integral part of the simulant instead of being added after the post-caustic-leach wash, according to TI-082. Therefore, there was not an extra dewater and wash step after the CrOOH slurry was added. For PEP Test D, the laboratory-scale oxidative leach test slurry sample was removed at the conclusion of the post-caustic-leach wash step (D_LAB_OL_3 and D_LAB_OL_4).

The two PEP Test D laboratory-scale tests were performed with different amounts of permanganate as PEP had inadvertently used an excess of permanganate in their testing. Therefore, one test was performed with the amount of permanganate that PEP had used in excess (D_LAB_OL_3), and one was performed using the required amount of permanganate based on the expected quantity of Cr in the washed slurry based on target removal of Cr during caustic leach (D_LAB_OL_4). PEP had inadvertently added excess permanganate to the vessel in performing the oxidative leach of Test D. The amounts of components used in these tests are shown in Table 6.54.

Table 6.54. PEP Parallel Oxidative Test Matrix

PEP Sample ID	Test ID	PEP Sample (g)	1 M NaMnO ₄ (g)
A_AOL_018_XX_2383_RHE_4	A_LAB_OL_1	707.13	92.85
B_02_AOL_023_XX_4297_CUF_4	B_LAB_OL_2	704.34	95.69
D_AOL_017_XX_5517_CUF_4	D_LAB_OL_3	753.42	46.60
D_AOL_017_XX_5517_CUF_4	D_LAB_OL_4	766.43	33.61

These tests were performed by placing the required amount of PEP simulant and sodium permanganate in the test vessel, attaching the lid, and stirring. The time zero (0 hr) sample was taken, and the test continued for 8 hours at 25 ± 2°C. Samples were taken at 1, 2, 3, 4, 5, 6, 7, and 8 hours and filtered immediately through a 0.45-μm syringe filter. These samples were then analyzed by ICP-AES for Al, Cr, and Na concentration at SWRI, and the results are shown in Table 6.55 through Table 6.57. The samples were also analyzed by IC for anion concentrations, which are shown in Table 6.58 through Table 6.61. Slurry samples were also taken at the beginning and end of the test. Some slurry samples were washed three times with 0.01M NaOH and others were not washed. These results are shown in Table 6.62 through Table 6.65. The density of the supernate and the slurry was measured and is shown in

Table 6.66 and Table 6.67, respectively. Table 6.68 through Table 6.71 show the measurements of the UDS in the slurries (both washed and unwashed).

Table 6.55. Supernate Al Analysis from PEP Parallel Test Oxidative Leach

Time (hrs)	A_LAB_OL_1 (mg Al/kg soln)	B_LAB_OL_1 (mg Al/kg soln)	D_LAB_OL_3 (mg Al/kg soln)	D_LAB_OL_4 (mg Al/kg soln)
Initial	330	247	412	419
0	170	117	387	369
1	183	135	347	398
2	186	141	322	346
3	182	146	303	340
4	186	149	303	342
5	187	145	305	341
6	187	143	293	333
7	188	143	297	336
8	184	147	293	334

Table 6.56. Supernate Cr Analysis from PEP Parallel Test Oxidative Leach

Time (hrs)	A_LAB_OL_1 (mg Cr/kg soln)	B_LAB_OL_1 (mg Cr/kg soln)	D_LAB_OL_3 (mg Cr/kg soln)	D_LAB_OL_4 (mg Cr/kg soln)
Initial	323	172	44.4	44.9
0	6,630	6,880	116	116
1	6,770	6,800	123	132
2	6,800	6,760	131	132
3	6,770	6,920	132	136
4	6,880	7,010	138	143
5	6,940	6,870	143	143
6	6,870	6,890	139	143
7	6,840	6,870	142	146
8	6,850	7,080	142	145

Table 6.57. Supernate Na Analysis from PEP Parallel Test Oxidative Leach

Time (hrs)	A_LAB_OL_1 (mg Na/kg soln)	B_LAB_OL_1 (mg Na/kg soln)	D_LAB_OL_3 (mg Na/kg soln)	D_LAB_OL_4 (mg Na/kg soln)
Initial	8,220	8,890	7,440	7,130
0	8,750	9,390	8,150	7,840
1	9,170	9,410	8,200	8,350
2	9,110	9,430	8,060	7,760
3	8,820	9,550	7,710	7,550
4	9,080	9,820	7,920	7,310
5	8,960	9,450	8,130	7,600
6	9,080	9,690	7,690	7,450
7	9,270	9,600	7,720	7,670
8	8,900	9,830	7,790	7,670

Table 6.58. Anion Analysis of A_LAB_OL_1 Supernate from Oxidative Leach Tests

Time (hrs)	Chloride (mg/kg soln)	Nitrate (mg/kg soln)	Nitrite (mg/kg soln)	Oxalate (mg/kg soln)	Phosphate (mg/kg soln)	Sulfate (mg/kg soln)
Initial	164	3,790	70.6	674	275	38.4
0	135	3,120	61.1	552	172	132
1	133	3,190	58.5	547	154	132
2	137	3,150	59.5	549	161	137
3	134	3,140	59.5	547	150	134
4	136	3,210	57.8	562	150	136
5	137	3,140	61.4	555	143	137
6	136	3,170	56.8	552	149	136
7	131	3,110	59.8	546	143	135
8	134	3,100	61.8	555	150	132

Table 6.59. Anion Analysis of B_LAB_OL_2 Supernate from Oxidative Leach Tests

Time (hrs)	Chloride (mg/kg soln)	Nitrate (mg/kg soln)	Nitrite (mg/kg soln)	Oxalate (mg/kg soln)	Phosphate (mg/kg soln)	Sulfate (mg/kg soln)
Initial	160	3,840	90.4	1,530	124	48.1
0	132	3,140	77.9	1,270	70.8	151
1	138	3,090	80.2	1,250	65.9	151
2	137	3,130	76.9	1,270	62.8	152
3	139	3,100	81.2	1,260	64.7	150
4	137	3,180	76.6	1,280	61.3	153
5	139	3,140	80.5	1,270	59.8	152
6	137	3,150	77.5	1,270	72.3	152
7	136	3,110	82.8	1,270	64.7	147
8	137	3,120	78.9	1,260	68.3	153

Table 6.60. Anion Analysis of D_LAB_OL_3 Supernate from Oxidative Leach Tests

Time (hrs)	Chloride (mg/kg soln)	Nitrate (mg/kg soln)	Nitrite (mg/kg soln)	Oxalate (mg/kg soln)	Phosphate (mg/kg soln)	Sulfate (mg/kg soln)
Initial	<17.9	509	145	6,990	59.1	141
0	14.3	483	129	7,980	60.7	186
1	16.0	483	130	7,990	68.0	190
2	<17.9	500	142	7,980	74.2	195
3	<16.3	483	136	7,860	72.9	189
4	<16.1	487	134	8,020	72.6	190
5	<17.6	500	137	8,030	76.0	191
6	<15.5	478	131	8,050	69.9	187
7	<18.1	487	137	7,950	64.0	191
8	<18.8	492	140	8,110	77.8	187

Table 6.61. Anion Analysis of D_LAB_OL_4 Supernate from Oxidative Leach Tests

Time (hrs)	Chloride (mg/kg soln)	Nitrate (mg/kg soln)	Nitrite (mg/kg soln)	Oxalate (mg/kg soln)	Phosphate (mg/kg soln)	Sulfate (mg/kg soln)
Initial	<17.4	523	152	7,470	60.4	156
0	14.2	487	134	7,610	61.6	179
1	<17.9	514	143	8,020	71.1	185
2	<16.6	500	138	7,890	68.0	177
3	16.0	492	135	7,850	63.1	179
4	<17.3	505	144	7,860	68.0	178
5	<19.6	518	146	7,860	70.5	183
6	<19.4	509	145	7,680	74.8	181
7	<19.2	514	144	7,870	72.0	182
8	<16.3	500	138	7,960	70.8	179

Table 6.62. Slurry Analysis from PEP Parallel Oxidative Leach Test A (Test 1)

	A_LAB_ OL_1_OS_SL (mg/kg slurry)	A_LAB_ OL_1_OSW_SL (mg/kg slurry)	A_LAB_ OL_1_IS_SL (mg/kg slurry)	A_LAB_ OL_1_ISW_SL (mg/kg slurry)	A_LAB_ OL_1_FS_SL (mg/kg slurry)	A_LAB_ OL_1_FSW_SL (mg/kg slurry)
	Original (before MnO ₄ ²⁻ added) Slurry	Original Washed (before MnO ₄ ²⁻ added) Slurry	Initial (after MnO ₄ ²⁻ added) Slurry	Initial (after MnO ₄ ²⁻ added) Washed Slurry	Final Slurry	Final Washed Slurry
Al	36,200	54,400	32,800	51,000	32,800	49,200
Ca	1,010	1,380	905	1,380	900	1,320
Cr	6,860	8,860	6,120	860	6,110	854
Fe	32,700	41,800	29,200	44,400	29,200	42,400
Mg	696	987	621	945	617	908
Mn	6,940	9,810	11,800	17,800	11,800	17,100
Ni	1,010	1,340	895	1,360	896	1,300
Na	10,100	4,220	11,300	4,880	10,900	4,710
P	131	199	130	247	121	210
Sr	382	511	341	523	344	496
Zr	466	714	402	833	382	703

Table 6.63. Slurry Analysis from PEP Parallel Oxidative Leach Test B (Test 2)

	B_LAB_ OL_2_OS_SL (mg/kg slurry)	B_LAB_ OL_2_OSW_SL (mg/kg slurry)	B_LAB_ OL_2_IS_SL (mg/kg slurry)	B_LAB_ OL_2_ISW_SL (mg/kg slurry)	B_LAB_ OL_2_FS_SL (mg/kg slurry)	B_LAB_ OL_2_FSW_SL (mg/kg slurry)
	Original (before MnO ₄ ²⁻ added) Slurry	Original Washed (before MnO ₄ ²⁻ added) Slurry	Initial (after MnO ₄ ²⁻ added) Slurry	Initial (after MnO ₄ ²⁻ added) Washed Slurry	Final Slurry	Final Washed Slurry
Al	40,700	50,600	34,700	54,000	34,600	47,000
Ca	1,150	1,370	997	1,410	1,020	1,260
Cr	6,660	7,820	5,770	540	5,970	544
Fe	36,600	44,300	31,900	46,400	33,100	41,200
Mg	695	846	606	844	618	762
Mn	7,840	9,580	12,600	18,100	12,900	15,900
Ni	1,110	1,360	977	1,420	1,010	1,250
Na	10,600	4,330	12,000	5,370	12,400	4,770
P	149	188	150	171	148	179
Sr	331	400	291	419	296	367
Zr	926	1,180	841	1,150	855	1,100

Table 6.64. Slurry Analysis from PEP Parallel Oxidative Leach Test D, Excess MnO_4^- (Test 3)

	D_LAB_ OL_3_OS_SL (mg/kg slurry)	D_LAB_ OL_3_OSW_SL (mg/kg slurry)	D_LAB_ OL_3_IS_SL (mg/kg slurry)	D_LAB_ OL_3_ISW_SL (mg/kg slurry)	D_LAB_ OL_3_FS_SL (mg/kg slurry)	D_LAB_ OL_3_FSW_SL (mg/kg slurry)
	Original (before MnO_4^{2-} added) Slurry	Original Washed (before MnO_4^{2-} added) Slurry	Initial (after MnO_4^{2-} added) Slurry	Initial (after MnO_4^{2-} added) Washed Slurry	Final Slurry	Final Washed Slurry
Al	55,600	71,000	52,200	66,200	52,700	65,300
Ca	1,070	1,390	1,010	1,240	1,010	1,290
Cr	204	221	193	114	193	118
Fe	34,500	45,700	32,600	40,500	32,300	41,600
Mg	652	852	614	755	615	792
Mn	7,560	10,000	9,700	11,800	9,850	12,700
Ni	1,050	1,420	996	1,240	981	1,270
Na	8,710	3,540	9,450	3,860	9,280	4,150
P	88.8	97.4	84.8	84.3	83.0	86.7
Sr	315	416	299	366	295	378
Zr	978	1,260	926	1,120	915	1,150

Table 6.65. Slurry Analysis from PEP Parallel Oxidative Leach Test D, Less MnO_4^- (Test 4)

	D_LAB_ OL_4_OS_SL (mg/kg slurry)	D_LAB_ OL_4_OSW_SL (mg/kg slurry)	D_LAB_ OL_4_IS_SL (mg/kg slurry)	D_LAB_ OL_4_ISW_SL (mg/kg slurry)	D_LAB_ OL_4_FS_SL (mg/kg slurry)	D_LAB_ OL_4_FSW_SL (mg/kg slurry)
	Original (before MnO_4^{2-} added) Slurry	Original Washed (before MnO_4^{2-} added) Slurry	Initial (after MnO_4^{2-} added) Slurry	Initial (after MnO_4^{2-} added) Washed Slurry	Final Slurry	Final Washed Slurry
Al	58,700	75,700	54,700	71,700	50,100	64,400
Ca	1,090	1,390	1,020	1,330	1,030	1,250
Cr	210	223	197	124	198	108
Fe	35,700	45,900	33,200	44,000	33,300	40,300
Mg	658	854	622	808	626	762
Mn	7,880	10,200	9,490	12,300	9,310	11,200
Ni	1,100	1,400	1,010	1,360	1,020	1,240
Na	8,540	3,380	8,970	3,990	9,270	3,690
P	91.7	103	89.0	91.2	87.3	87.1
Sr	321	437	310	393	302	368
Zr	1,000	1,300	953	1,240	943	1,120

Table 6.66. PEP Parallel Oxidative Test Supernate Density

Sample ID	Density (g/mL)	Sample ID	Density (g/mL)
A_LAB_OL_1_ORG_SUP	1.018	D_LAB_OL_3_ORG_SUP	1.024
A_LAB_OL_1_INA_SUP	1.044	D_LAB_OL_3_INA_SUP	1.029
A_LAB_OL_1_001	1.030	D_LAB_OL_3_001	1.017
A_LAB_OL_1_002	1.045	D_LAB_OL_3_002	1.030
A_LAB_OL_1_003	1.051	D_LAB_OL_3_003	1.027
A_LAB_OL_1_004	1.036	D_LAB_OL_3_004	1.024
A_LAB_OL_1_005	1.043	D_LAB_OL_3_005	1.037
A_LAB_OL_1_006	1.046	D_LAB_OL_3_006	1.027
A_LAB_OL_1_007	1.042	D_LAB_OL_3_007	1.028
A_LAB_OL_1_008	1.042	D_LAB_OL_3_008	1.034
B_LAB_OL_2_ORG_SUP	1.022	D_LAB_OL_4_ORG_SUP	1.016
B_LAB_OL_2_INA_SUP	1.043	D_LAB_OL_4_INA_SUP	1.024
B_LAB_OL_2_001	1.046	D_LAB_OL_4_001	1.031
B_LAB_OL_2_002	1.042	D_LAB_OL_4_002	1.029
B_LAB_OL_2_003	1.043	D_LAB_OL_4_003	1.023
B_LAB_OL_2_004	1.047	D_LAB_OL_4_004	1.029
B_LAB_OL_2_005	1.040	D_LAB_OL_4_005	1.026
B_LAB_OL_2_006	1.047	D_LAB_OL_4_006	1.029
B_LAB_OL_2_007	1.046	D_LAB_OL_4_007	1.031
B_LAB_OL_2_008	1.041	D_LAB_OL_4_008	1.030

Table 6.67. PEP Parallel Oxidative Test Slurry Density

Sample ID	Sample Description	Density (g/mL)	Sample ID	Sample Description	Density (g/mL)
A_LAB_OL_1_FS_SL	Final Slurry-Test 1	1.145	D_LAB_OL_3_FS_SL	Final Slurry-Test 3	1.156
A_LAB_OL_1_FSW_SL	Final Washed Slurry-Test 1	1.149	D_LAB_OL_3_FSW_SL	Final Washed Slurry-Test 3	1.154
A_LAB_OL_1_IS_SL	Initial (after MnO ₄ ²⁻ added) Slurry-Test 1	1.148	D_LAB_OL_3_IS_SL	Initial (after MnO ₄ ²⁻ added) Slurry-Test 3	1.149
A_LAB_OL_1_ISW_SL	Initial (after MnO ₄ ²⁻ added) Washed Slurry-Test 1	1.148	D_LAB_OL_3_ISW_SL	Initial (after MnO ₄ ²⁻ added) Washed Slurry-Test 3	1.143
A_LAB_OL_1_OS_SL	Original (before MnO ₄ ²⁻ added) Slurry-Test 1	1.143	D_LAB_OL_3_OS_SL	Original (before MnO ₄ ²⁻ added) Slurry-Test 3	1.161
A_LAB_OL_1_OWS_SL	Original Washed (before MnO ₄ ²⁻ added) Slurry-Test 1	1.211	D_LAB_OL_3_OWS_SL	Original Washed (before MnO ₄ ²⁻ added) Slurry-Test 3	1.200
B_LAB_OL_2_FS_SL	Final Slurry-Test 2	1.151	D_LAB_OL_4_FS_SL	Final Slurry-Test 4	1.159
B_LAB_OL_2_FSW_SL	Final Washed Slurry-Test 2	1.141	D_LAB_OL_4_FSW_SL	Final Washed Slurry-Test 4	1.173
B_LAB_OL_2_IS_SL	Initial (after MnO ₄ ²⁻ added) Slurry-Test 2	1.153	D_LAB_OL_4_IS_SL	Initial (after MnO ₄ ²⁻ added) Slurry-Test 4	1.141
B_LAB_OL_2_ISW_SL	Initial (after MnO ₄ ²⁻ added) Washed Slurry-Test 2	1.155	D_LAB_OL_4_ISW_SL	Initial (after MnO ₄ ²⁻ added) Washed Slurry-Test 4	1.180
B_LAB_OL_2_OS_SL	Original (before MnO ₄ ²⁻ added) Slurry-Test 2	1.149	D_LAB_OL_4_OS_SL	Original (before MnO ₄ ²⁻ added) Slurry-Test 4	1.176
B_LAB_OL_2_OWS_SL	Original Washed (before MnO ₄ ²⁻ added) Slurry-Test 2	1.166	D_LAB_OL_4_OWS_SL	Original Washed (before MnO ₄ ²⁻ added) Slurry-Test 4	1.224

Table 6.68. PEP Parallel Oxidative Test A_LAB_OL_1 Physical Properties

Property	A_LAB_OL_1					
	FS_SL	FSW_SL	IS_SL	ISW_SL	OS_SL	OWS_SL
Sample Description	Final Slurry	Final Washed Slurry	Initial (after MnO ₄ ²⁻ added) Slurry	Initial (after MnO ₄ ²⁻ added) Washed Slurry	Original (before MnO ₄ ²⁻ added) Slurry	Original (before MnO ₄ ²⁻ added) Washed Slurry
Bulk Density (g/mL)	1.170	1.247	1.194	1.205	1.165	1.216
Density of Cent. Solids (g/mL)	1.529	1.638	1.765	1.423	1.425	1.423
Vol% of Cent. Solids	30.4	41.5	27.3	46.5	36.4	46.9
Wt% Cent. Solids	39.8	54.5	40.3	55.0	44.5	54.9
Supernatant Density (g/mL)	1.008	0.955	0.968	1.001	1.005	1.019
Wt% Total Solids	19.3	24.6	19.3	25.3	20.4	25.8
Wt% Oven Dried Solids	43.6	45.0	42.9	45.8	43.1	46.7
Wt% UDS	16.6	24.5	16.5	25.1	18.6	25.6
Wt% Dissolved Solids	3.30	0.236	3.33	0.365	2.23	0.302
Wt% Supernatant Liquid	59.9	44.8	59.0	44.4	54.9	44.5

Table 6.69. PEP Parallel Oxidative Test B LAB_OL_2 Physical Properties

Property	B_LAB_OL_2					
	FS_SL	FSW_SL	IS_SL	ISW_SL	OS_SL	OWS_SL
Sample Description	Final Slurry	Final Washed Slurry	Initial (after MnO ₄ ²⁻ added) Slurry	Initial (after MnO ₄ ²⁻ added) Washed Slurry	Original (before MnO ₄ ²⁻ added) Slurry	Original (before MnO ₄ ²⁻ added) Washed Slurry
Bulk Density (g/mL)	1.208	1.226	1.186	1.255	1.255	1.184
Density of Cent. Solids (g/mL)	1.500	1.482	1.460	1.635	1.418	1.357
Vol% of Cent. Solids	36.4	42.9	36.4	44.1	43.6	50.0
Wt% Cent. Solids	45.2	51.8	44.8	57.5	49.3	57.3
Supernatant Density (g/mL)	1.032	1.030	1.024	0.942	1.117	0.995
Wt% Total Solids	21.0	23.0	20.9	26.1	22.5	25.2
Wt% Oven Dried Solids	42.4	44.1	42.5	45.2	43.1	43.9
Wt% UDS	18.2	22.8	18.1	25.9	20.5	25.1
Wt% Dissolved Solids	3.52	0.263	3.46	0.268	2.52	0.205
Wt% Supernatant Liquid	54.3	48.0	54.9	42.0	50.2	42.0

Table 6.70. PEP Parallel Test D LAB_OL_3 Physical Properties

Property	D_LAB_OL_3					
	FS_SL	FSW_SL	IS_SL	ISW_SL	OS_SL	OWS_SL
Sample Description	Final Slurry	Final Washed Slurry	Initial (after MnO ₄ ²⁻ added) Slurry	Initial (after MnO ₄ ²⁻ added) Washed Slurry	Original (before MnO ₄ ²⁻ added) Slurry	Original (before MnO ₄ ²⁻ added) Washed Slurry
Bulk Density (g/mL)	1.169	1.218	1.183	1.216	1.163	1.246
Density of Cent. Solids (g/mL)	1.470	1.436	1.507	1.366	1.387	1.338
Vol% of Cent. Solids	41.0	51.2	40.0	52.1	42.5	56.0
Wt% Cent. Solids	51.6	60.4	51.0	58.5	50.7	60.1
Supernate Density (g/mL)	0.940	0.978	0.954	1.036	0.986	1.108
Wt% Total Solids	23.2	27.5	23.1	26.6	23.8	28.5
Wt% Oven Dried Solids	42.8	45.3	43.2	45.3	44.8	47.3
Wt% UDS	21.3	27.2	21.3	26.3	22.1	28.4
Wt% Dissolved Solids	2.40	0.476	2.34	0.361	2.18	0.160
Wt% Supernate Liquid	47.4	39.1	48.4	40.8	48.8	39.1

Table 6.71. PEP Parallel Oxidative Test D LAB_OL_4 Physical Properties

Property	D_LAB_OL_4					
	FS_SL	FSW_SL	IS_SL	ISW_SL	OS_SL	OWS_SL
Sample Description	Final Slurry	Final Washed Slurry	Initial (after MnO ₄ ²⁻ added) Slurry	Initial (after MnO ₄ ²⁻ added) Washed Slurry	Original (before MnO ₄ ²⁻ added) Slurry	Original (before MnO ₄ ²⁻ added) Washed Slurry
Bulk Density (g/mL)	1.116	1.177	1.255	1.286	1.196	1.262
Density of Cent. Solids (g/mL)	1.277	1.288	1.522	1.585	1.414	1.439
Vol% of Cent. Solids	45.0	52.5	41.7	50.0	42.1	52.6
Wt% Cent. Solids	51.5	57.4	50.5	61.6	49.8	60.1
Supernate Density (g/mL)	0.974	1.017	1.055	0.968	1.025	1.047
Wt% Total Solids	23.4	26.0	23.3	28.2	23.9	28.3
Wt% Oven Dried Solids	43.2	45.1	43.9	45.5	45.8	46.9
Wt% UDS	21.6	25.8	21.5	27.9	22.2	28.1
Wt% Dissolved Solids	2.27	0.197	2.31	0.408	2.18	0.159
Wt% Supernate Liquid	48.0	41.0	49.0	37.6	49.6	39.3

7.0 Precipitation Study Results

Significant post-filter precipitation was observed in the post-caustic-leachate and wash solutions while the leaching and ultrafiltration process was being demonstrated in the PEP. Precipitation in this stream could lead to accumulation of precipitates in filtrate receipt vessels and in the feed to the ion exchange column. The consequences of post-filtration precipitation in the feeds to the ion-exchange column will have a very significant effect on the operability of the unit and the pretreatment process. Therefore, it is essential to develop an understanding of the post-filtration precipitation phenomenon.

This section contains the results of several different tests and observations that were performed on these samples, including:

- Post-filtration precipitation of Test A solids in the wash solutions
- Blending of Test A washes and blending of Test A washes with the Test A leachate
- Observations of Test A solids in the leachate before blending
- Observations of Test B and Test D solids in the initial concentrations without blending
- Analysis by polarized light microscopy and PSD of Test D leachate precipitation and wash post-filtration precipitation.

In PEP Test A, feed stored in HLP-VSL-T22 with simulant at 5.5-wt% UDS was transferred to either fill vessel UFP-VSL-T01A or vessel UFP-VSL-T01B in six separate batches. To each simulant batch, 19 M NaOH (nominal concentration) was added, and caustic leaching was carried out by using steam sparging to raise the temperature to 98°C for 16 hr, following which the partially cooled leached slurry from all six batches was transferred to UFP-VSL-T02A for solids concentration. Caustic leaching, cooling, and transferring to UFP-VSL-T02A alternated between vessel UFP-VSL-T01A and vessel UFP-VSL-T01B for a total of six batches. During caustic leaching, AFA was added to maintain a target concentration of 350 ppm before starting the post-caustic-leach wash. Solids concentration continued until UFP-VSL-T02A was filled with leached slurry concentrated to 18.3-wt% UDS for the washing test. The oxalate was present in excess in the solids, and both the oxalate and phosphate were present at the solubility limits in the supernate. Compared to the actual waste, the oxalate was high, but not out of the range possible for the WTP during pretreatment, and the phosphate was in the range that the WTP pretreatment may encounter (and even lower than some) because no phosphate was present in the simulant solids whereas it can be in the actual waste.

The concentrated caustic-leached solids in UFP-VSL-T02A were washed incrementally with 0.01 M NaOH. The wash liquid was added in steps, 11 gallons target volume for each step, 100 steps total. The wash liquid was injected in-line to the filter loop while the pumps ran and permeate was extracted by the filters. During every third wash step, AFA was added to maintain a target concentration of 350 ppm. Wash liquid additions were initiated when the level in vessel UFP-VSL-T02A dropped below a set value, occurring approximately every 4 minutes, except between batches 7 and 8. Between batches 7 and 8, there was a 14-hr hold time to address recirculation pump problems. During the solids washing, permeate was continuously removed at a rate between 4 and 17 kg/min by ultrafiltration through all five filter bundles. In each wash step, permeate was sampled in 1-L bottles and then transferred to the Applied Process Engineering Laboratory (APEL) for further testing.

The objective of the tests described here was to evaluate the propensity of the permeates from the PEP post-caustic-leach wash solutions to precipitate solids when blended in various ratios as well as when blended with leachate. The following PEP permeate blending scenarios were selected to cover the spectrum of potential permeate blending scenarios as well as to maximize the aluminate and oxalate solubility ranges. Only the samples from PEP Test A were blended and then evaluated for precipitates based on the results obtained in this testing and due to BNI's direction per e-mail confirmation on July 1, 2009, following up verbal instruction.^(a) Only Test D polarized light microscopy and particle size analysis were performed during this work. Additional analysis of Test D and Test B are described in WTP-RPT-205.^(b)

All of the odd-numbered wash-step permeate samples were stored at room temperature (~18 to 22°C) for 10 days and then examined for precipitates. A large majority (38 out of 50) of them contained significant precipitates as shown in Table 7.1. The precipitates from sample bottles #2341 (wash step #3) and #2367 (wash step #29) were examined by X-ray diffraction (XRD) to determine their composition as shown in Figure 7.1 and Figure 7.2. These showed that the majority of the precipitate is composed of oxalate and phosphate and not aluminum.

Table 7.1. PEP Test A Wash Permeate Samples

Sample ID	Wash Step #	Solids	Solids Description
2339	1	3	Fine white powder type crystal and phosphate-type rods mixed
2341	3	3	Fine white powder type crystal
2343	5	3	Fine white powder type crystal
2345	7	3	Phosphate-type rods only
2347	9	3	¼ in needle crystals perfectly uniform rods, no other crystal shapes
2349	11	3	Phosphate-type rods only
2351	13	3	Phosphate-type rods only
2353	15	3	Phosphate-type rods only
2355	17	4	Crystals attached to bottom of container in solid puck
2357	19	4	Crystals attached to bottom of container in solid puck
2359	21	4	Crystals attached to bottom of container in solid puck
2361	23	4	Crystals attached to bottom of container in solid puck
2363	25	5	Crystals attached to bottom of container in solid puck
2365	27	5	Crystals attached to bottom of container in solid puck
2367	29	5	Crystals attached to bottom of container in solid puck
2369	31	4	Large diameter rectangular , clear crystals
2371	33	3	¼-in. needle crystals non-attached to bottle
2373	35	3	¼-in. needle crystals non-attached to bottle
2375	37	3	¼-in. needle crystals non-attached to bottle
2557	40	4	¼-in. needle crystals non-attached to bottle
2559	42	4	¼-in. needle crystals
2561	44	4	¼-in. needle crystals
2563	46	4	¼-in. needle crystals
2565	48	4	¼-in. needle crystals

(a) E-mail titled "E-mail Request" from Parameshwaran S Sundar on July 1, 2009 to Reid Peterson.

(b) RL Russell, RA Peterson, DE Rinehart, and JV Crum. 2009. *Results of the Laboratory Precipitate Study from PEP Simulant*. WTP-RPT-205, Rev. A, Bechtel National Inc., Richland, Washington.

Table 7.1. PEP Test A Wash Permeate Samples

Sample ID	Wash Step #	Solids	Solids Description
2567	50	4	¼-in. needle crystals
2569	52	4	¼-in. needle crystals
2571	54	4	¼-in. needle crystals
2573	56	4	¼-in. needle crystals
2575	58	4	¼-in. needle crystals
2577	60	4	¼-in. needle crystals
2579	62	4	¼-in. needle crystals
2581	64	4	¼-in. needle crystals
2583	66	4	¼-in. needle crystals
2585	68	4	¼-in. needle crystals
2587	70	4	¼-in. needle crystals
2589	72	4	¼-in. needle crystals
2591	74	4	¼-in. needle crystals
2593	76	1	~15 ¼-in. crystals non-attached to bottle
2595	78	0	No precipitate visible
2597	80	0	No precipitate visible
2621	82	0	No precipitate visible
2623	84	0	No precipitate visible
2625	86	0	No precipitate visible
2627	88	0	No precipitate visible
2629	90	0	No precipitate visible
2631	92	0	No precipitate visible
2633	94	0	No precipitate visible
2635	96	0	No precipitate visible
2637	98	0	No precipitate visible
2639	100	0	No precipitate visible

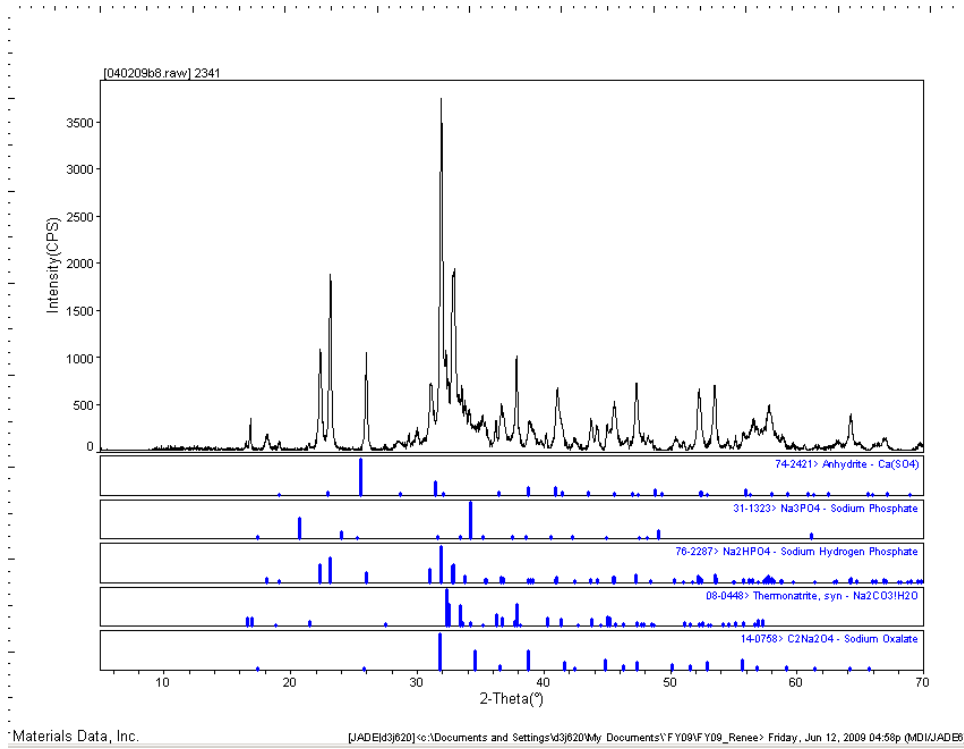

Figure 7.1. XRD Pattern of Crystals from Test A Wash Step #3 (Sample Bottle # 2341)

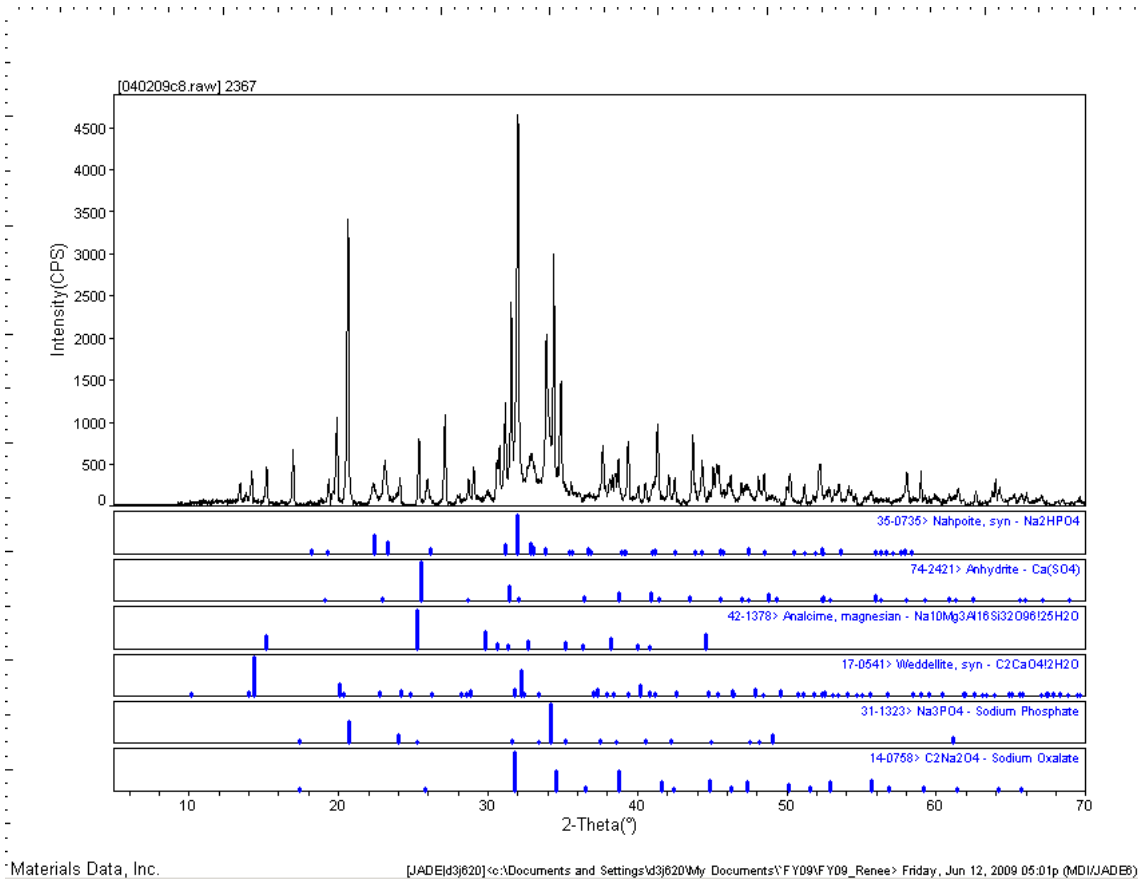

Figure 7.2. XRD Pattern of Crystals from Test A Wash #29 (Sample Bottle # 2367)

The solids were filtered, air-dried, and weighed for the odd-numbered wash samples with a Na concentration greater than 1.8 M. The weights are given in Table 7.2 along with the weight percent UDS present. Even after filtering, crystals continued to form in the supernate over the next month. Figure 7.3 shows the dried crystals for several of the samples.

Table 7.2. Weights of Filtered Solids in Odd-Numbered Test A Samples

PEP Sample ID	PEP Post-Caustic-Leach Wash Step #	Weight of Solids (g)	Wt% UDS
A_00PF1_015_XX_2339_ARC_4	1	0.619	0.048
A_00PF1_015_XX_2341_ARC_4	3	1.99	0.17
A_00PF1_015_XX_2343_ARC_4	5	2.76	0.22
A_00PF1_015_XX_2345_ARC_4	7	2.94	0.24
A_00PF1_015_XX_2347_ARC_4	9	2.55	0.24
A_00PF1_015_XX_2349_ARC_4	11	2.61	0.24
A_00PF1_015_XX_2351_ARC_4	13	2.84	0.26
A_00PF1_015_XX_2353_ARC_4	15	2.86	0.26
A_00PF1_015_XX_2355_ARC_4	17	3.23	0.30
A_00PF1_015_XX_2357_ARC_4	19	3.03	0.27
A_00PF1_015_XX_2359_ARC_4	21	3.41	0.32
A_00PF1_015_XX_2361_ARC_4	23	3.57	0.34
A_00PF1_015_XX_2363_ARC_4	25	4.69	0.44
A_00PF1_015_XX_2365_ARC_4	27	3.51	0.34
A_00PF1_015_XX_2367_ARC_4	29	0.924	0.090
A_00PF1_015_XX_2369_ARC_4	31	0.388	0.038



Figure 7.3. Air-Dried Crystals from Various Filtered Odd-Numbered Wash Step Permeate Samples

The even-numbered wash-step permeate samples collected before the slurry sodium ion concentration dropped below 1.8 M (sample # 2340 to #2368) all formed crystals covering the bottom of the sample bottle before they could be blended in the correct ratios. Therefore, the bottles were placed in an oven at 80°C for 48 hours to re-dissolve the crystals. After the crystals were re-dissolved, 200-mL aliquots of each of these even-numbered wash permeate samples were combined in a single container and stored at room temperature (~18 to 22°C) for 10 days. Significant amounts of needle-like crystals were observed in this mixture after 9 days that continued to grow over time as shown in Figure 7.4 and Figure 7.5. These crystals were then filtered through a 0.45- μ m filter and air-dried as shown in Figure 7.6. There were 34.48 g of filtered crystals present after drying, which is equivalent to 0.99-wt% UDS. After about 5 days, crystals began to form once again in the filtered permeate as shown in Figure 7.7 and appeared to be much smaller crystals than previously.

Another mixture was prepared by taking 200-mL aliquots of each of the same even-numbered wash step permeate samples and combining them in a single container with an equal volume of post-caustic leachate. This 6-L solution mixture was then stored at room temperature (~18 to 22°C) for 10 days. Significant amounts of crystals were observed to form in this solution and appeared to continue to grow over time. These crystals were then filtered through a 0.45- μ m filter and air-dried. There were 57.72 g of filtered crystals present after drying, which is equivalent to 0.79-wt% UDS. These crystals appeared to be smaller and finer than the crystals present in the previous mixture of just the wash-step permeate samples as shown in Figure 7.8.



Figure 7.4. Even-Numbered Wash-Step Permeate Blend Crystals

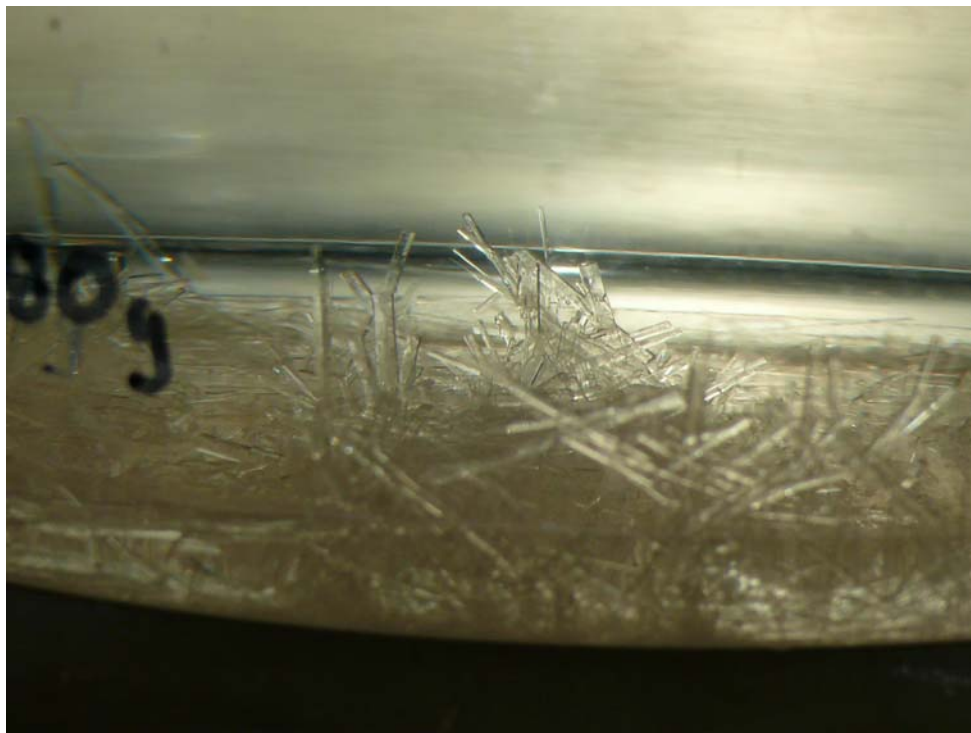

Figure 7.5. More Even-Numbered Wash-Step Permeate Blend Crystals



Figure 7.6. Air-Dried Crystals from the Even-Numbered Wash-Step Permeate Mixture



Figure 7.7. Crystals Forming After Filtration of Even-Numbered Wash-Step Permeate Blend



Figure 7.8. Air-Dried Crystals from the 1:1 Wash-Step Permeate: Leachate Mixture

A 2-L permeate sample was collected on February 2, 2009 at 10:01 near the end of the post-caustic-leach solids concentration process for Test A (Sample ID # A_00PF1_007_XX_2555_ARC_4). This sample was maintained at laboratory temperature (~18 to 22°C) for about 3 months. During the first 2 months, no precipitate appeared. However, during the last month, several needle-like crystals grew in the sample as seen in Figure 7.9. These crystals were then filtered, air-dried, and weighed. There were 2.88 g of crystals present, which is equivalent to 0.26-wt%.

A 2-L permeate sample was collected near the end of the initial solids concentration processes in Tests B and D. These samples were maintained at laboratory temperature (~18 to 22°C) for about 2 months. No precipitates were observed during this timeframe in either sample. Only the PEP Test D washes and leachate were looked at with PLM and had particle size distribution measured from the PLM photos. The PEP Tests B and D leachates were not analyzed during this testing. What analysis was performed on these leachates will be reported in WTP-RPT-205.^(a)

(a) RL Russell, RA Peterson, DE Rinehart, and JV Crum. 2009. *Results of the Laboratory Precipitate Study from PEP Simulant*. WTP-RPT-205, Rev. A, Bechtel National Inc., Richland, Washington.



Figure 7.9. Crystals in Test A Initial Solids Concentration Permeate

PEP Test D post-caustic-leach water washing began on March 30, 2009 at 3:48 and continued until 12:00 using 53 wash steps. A 1-liter permeate sample was taken with each wash step and then transferred to a heated trailer that was kept at $80 \pm 1^\circ\text{F}$.

Four samples from PEP Test D post-caustic-leach water washing were examined with polarized light microscopy (PLM) to determine particle size and composition of the precipitate that had formed. Pictures of crystals in the very small samples withdrawn from the wash permeate PEP samples were taken after the samples had been at laboratory temperature (~ 18 to 22°C) for 6 days and 4 hours without mixing. A couple of drops of solution with crystals present were removed from the bottle using a large opening pipette and placed on a microscope slide.

To determine the particle composition, the microscope slides were placed on the polarized light microscope after 8 days and 21 hours without mixing and compared to the standard polarized light microscope pictures of sodium phosphate and sodium oxalate. These pictures show that the crystals were mainly sodium phosphate with some sodium oxalate, as shown in Figure 7.10 through Figure 7.13 by the standard PLM photos included next to the figure.

To determine particle size, several pictures at $50\times$ magnification on a non-polarized light microscope were taken at different areas of the microscope slide. These pictures were scaled, and each particle on the pictures was measured for a total of approximately 100 particles. Pictures were taken again after another week (6 days and 20.5 hours) to determine the crystal growth in the samples. The crystal size growth is shown in Figure 7.14 through Figure 7.17 by plotting the cumulative particle size measured from the photographs and given in tabular form in Table 7.3 through Table 7.6. Two samples, Sample Bottle #D_00PF1_015_XX_5444_ARC_4 (wash #8) and Sample Bottle #D_00PF1_015_XX_5476_ARC_4

(wash #40), appeared to decrease in size over time because the crystals had to be broken up to remove them from the sample bottle and prepare a microscope slide. Therefore, this is probably not an accurate assessment of the crystal growth in these samples. The other samples continued to show the particle size increasing over time.

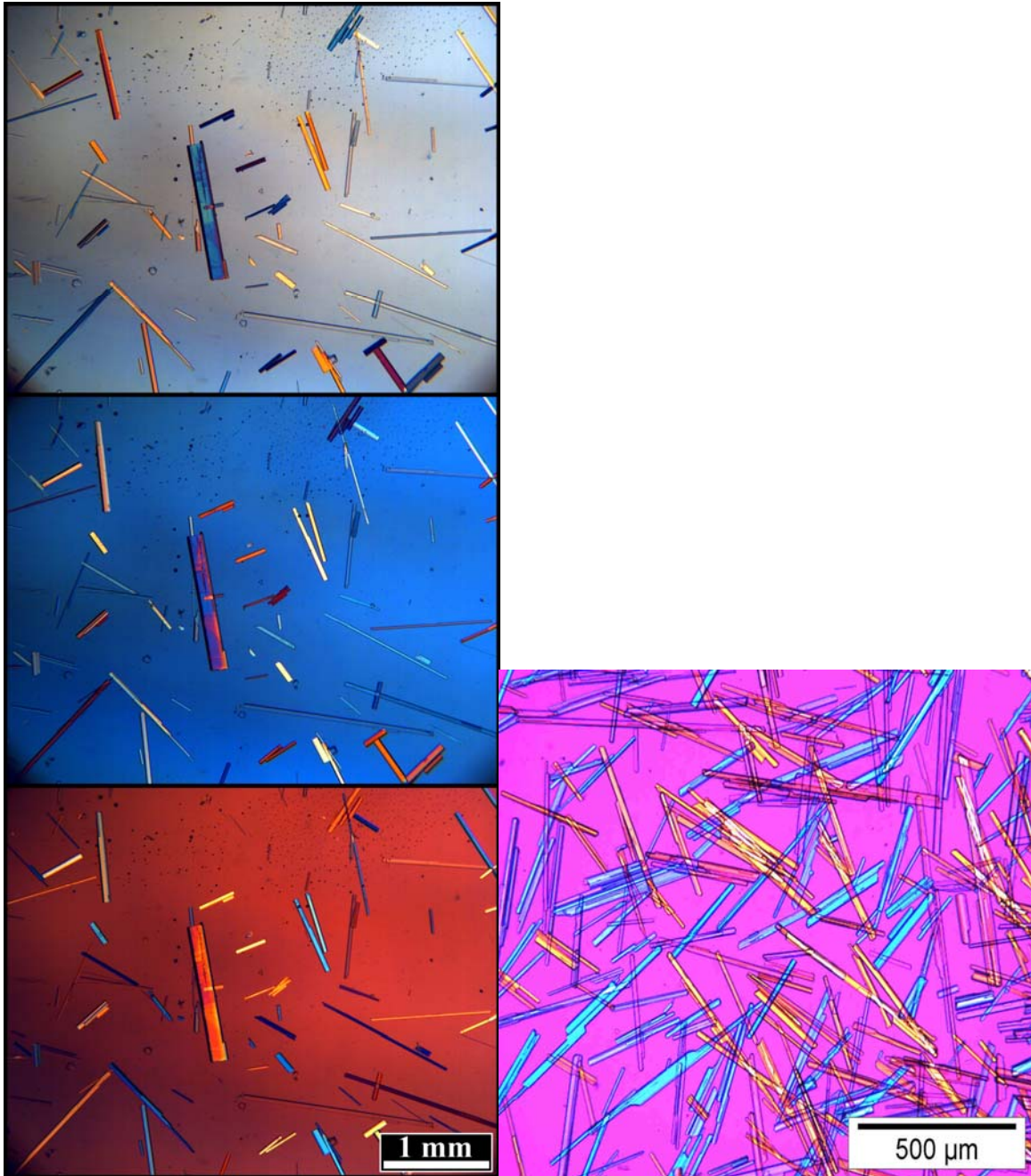

Figure 7.10. Polarized Light Picture of Sample Bottle #D_00PF1_015_XX_5653_ARC_4 (post-caustic-leach dewater) with a Standard Na_3PO_4 Picture Beside it

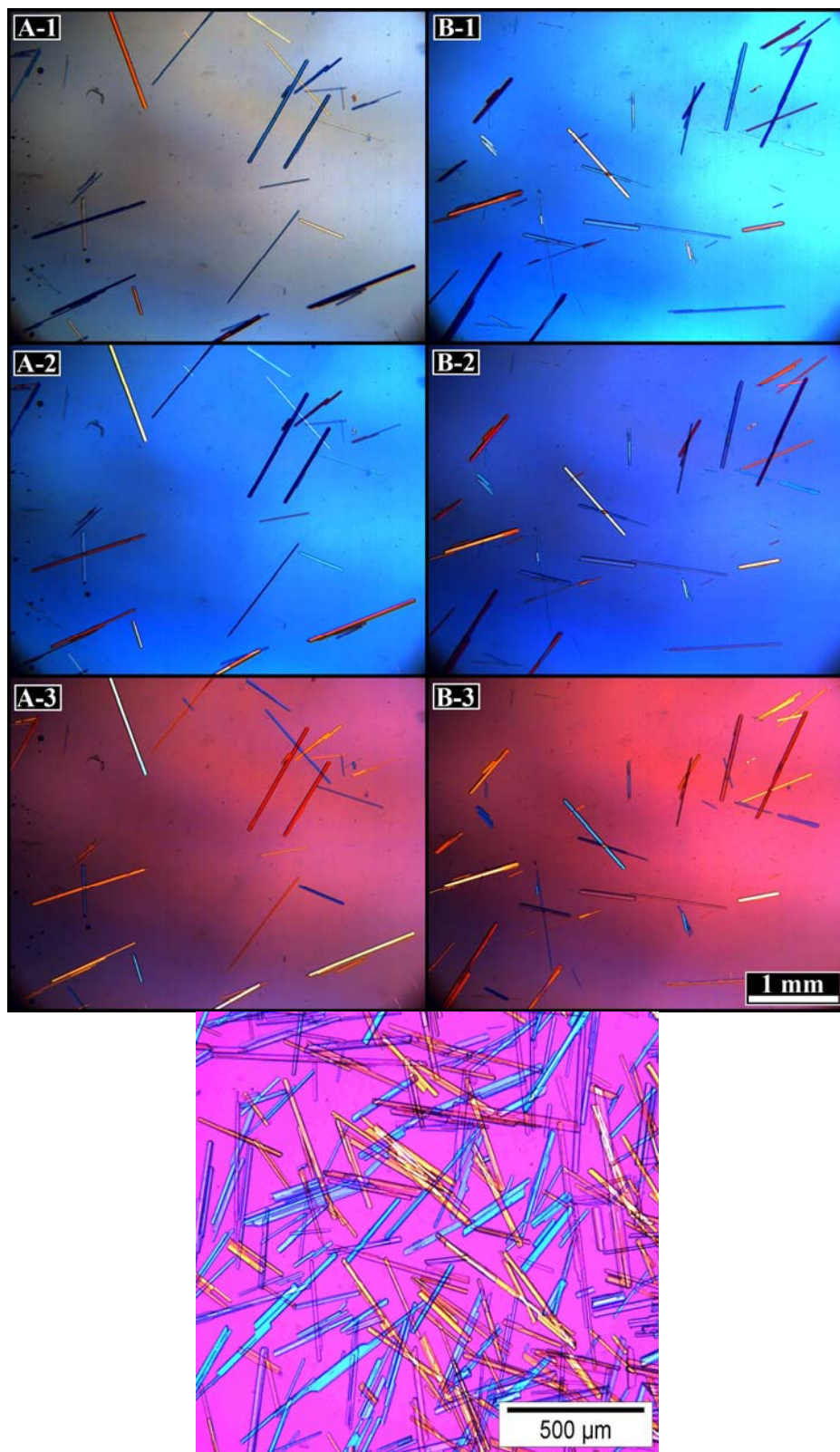

Figure 7.11. Polarized Light Picture of Sample Bottle #D_00PF1_015_XX_5444_ARC_4 (wash #8) with a Standard Na_3PO_4 Picture Under it

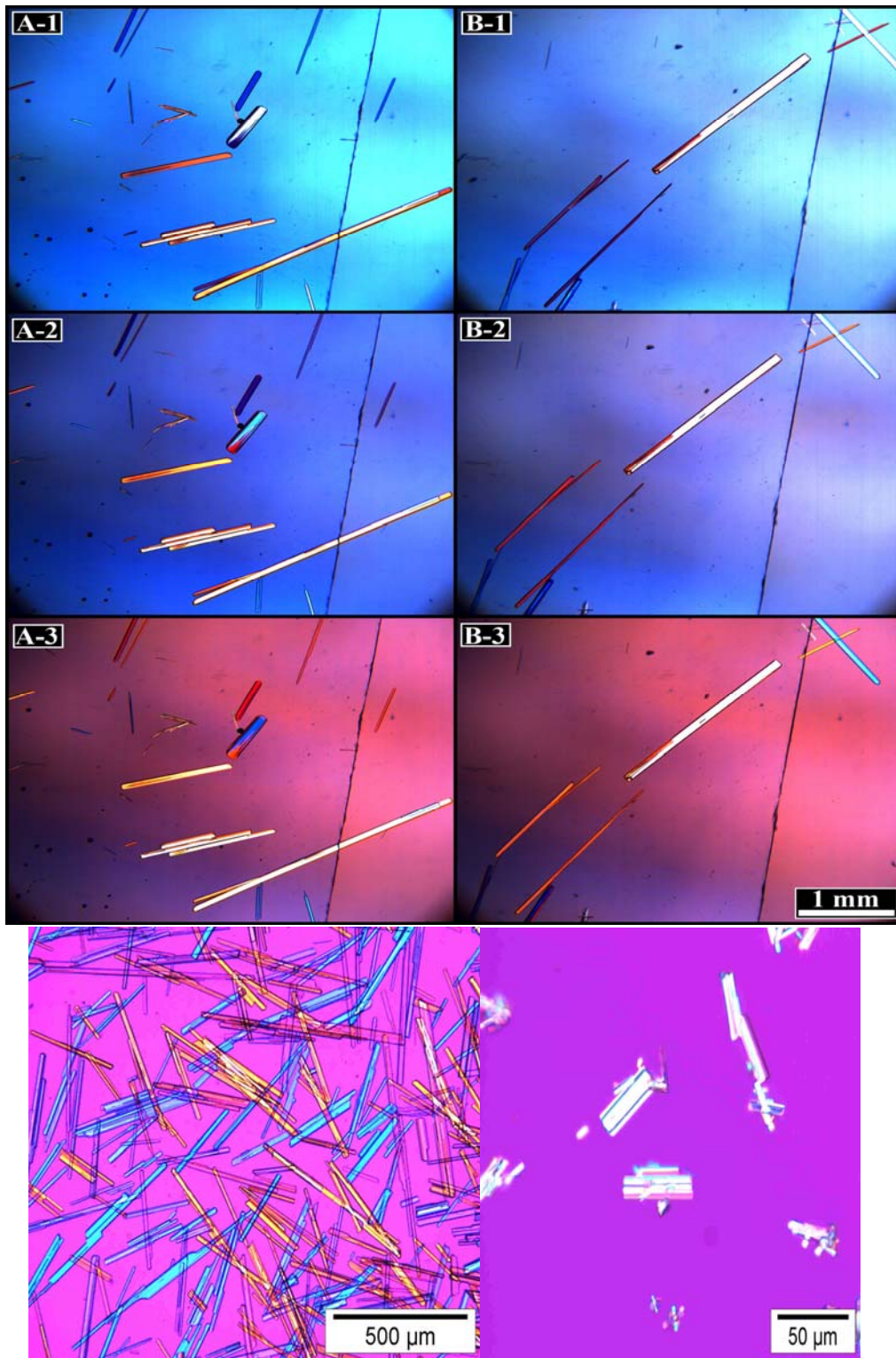

Figure 7.12. Polarized Light Picture of Sample Bottle #D_00PF1_015_XX_5675_ARC_4 (wash #13) with a Standard Na_3PO_4 Picture (on the left) and a Standard $\text{Na}_2\text{C}_2\text{O}_4$ Picture (on the right) Under it

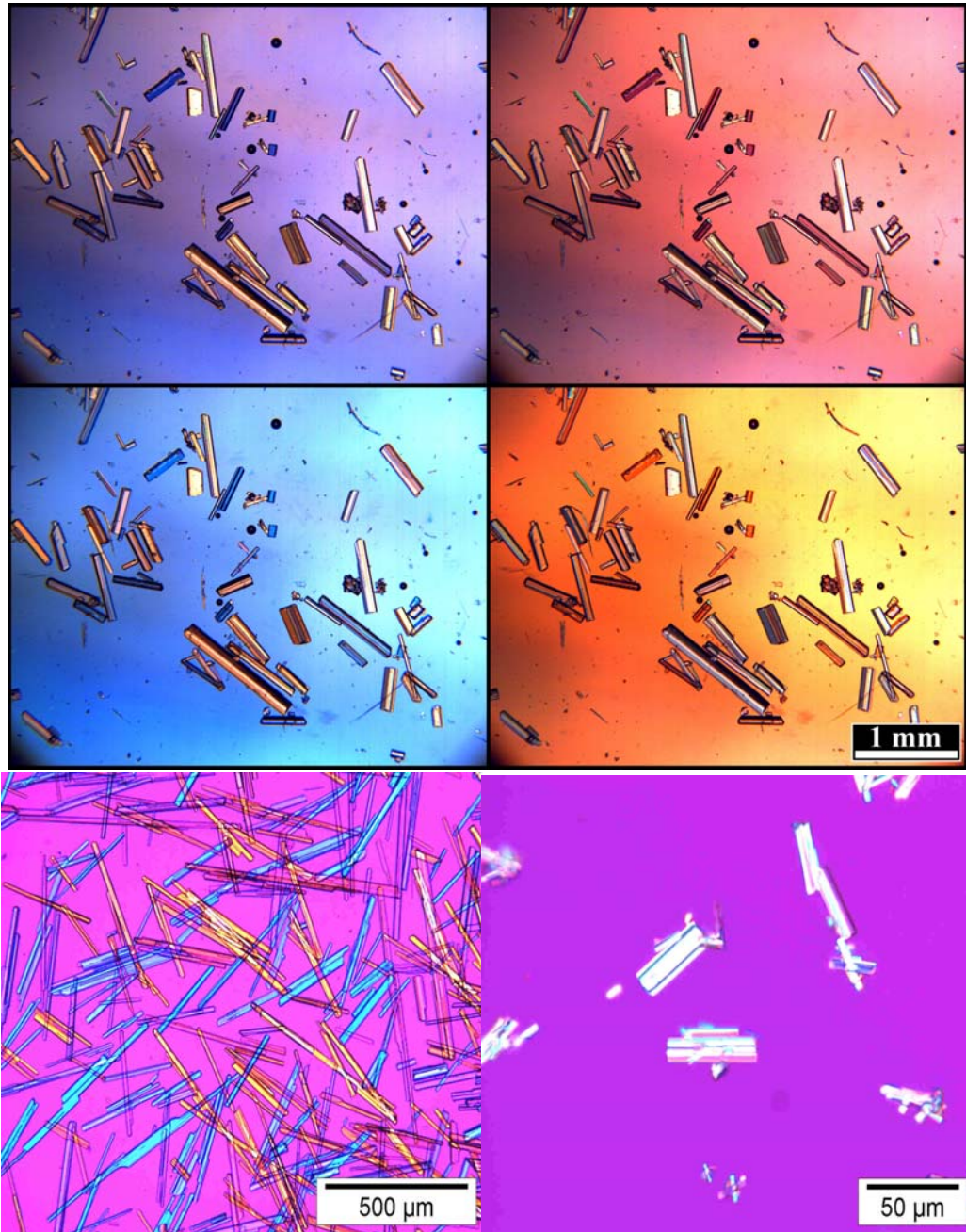

Figure 7.13. Polarized Light Picture of Sample Bottle #D_00PF1_015_XX_5476_ARC_4 (wash #40) with a Standard Na_3PO_4 Picture (on the left) and a Standard $\text{Na}_2\text{C}_2\text{O}_4$ Picture (on the right) Under it

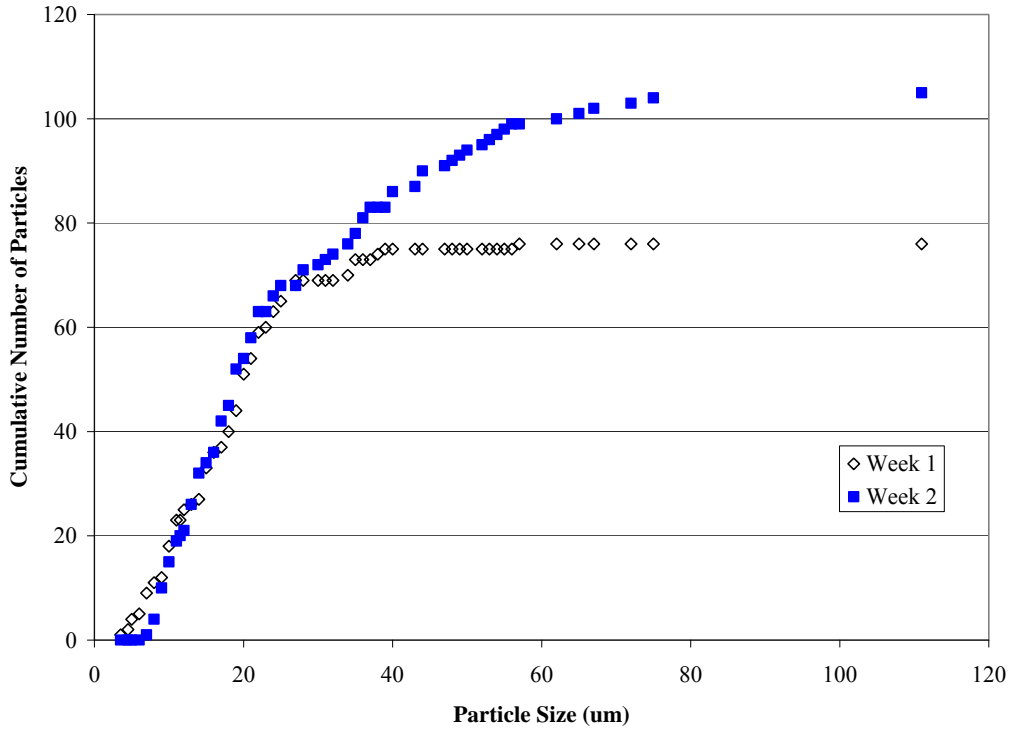

Figure 7.14. Particle Length Distribution of Sample Bottle #D_00PF1_015_XX_5653_ARC_4 (post-caustic-leach dewater)

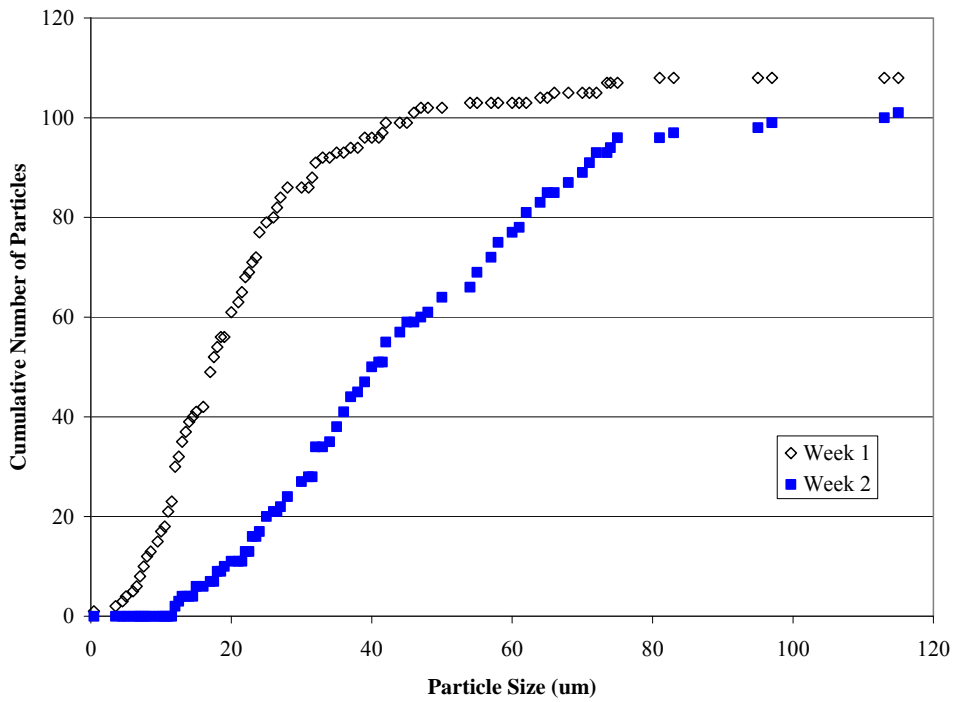

Figure 7.15. Particle Length Distribution of Sample Bottle #D_00PF1_015_XX_5444_ARC_4 (wash #8)

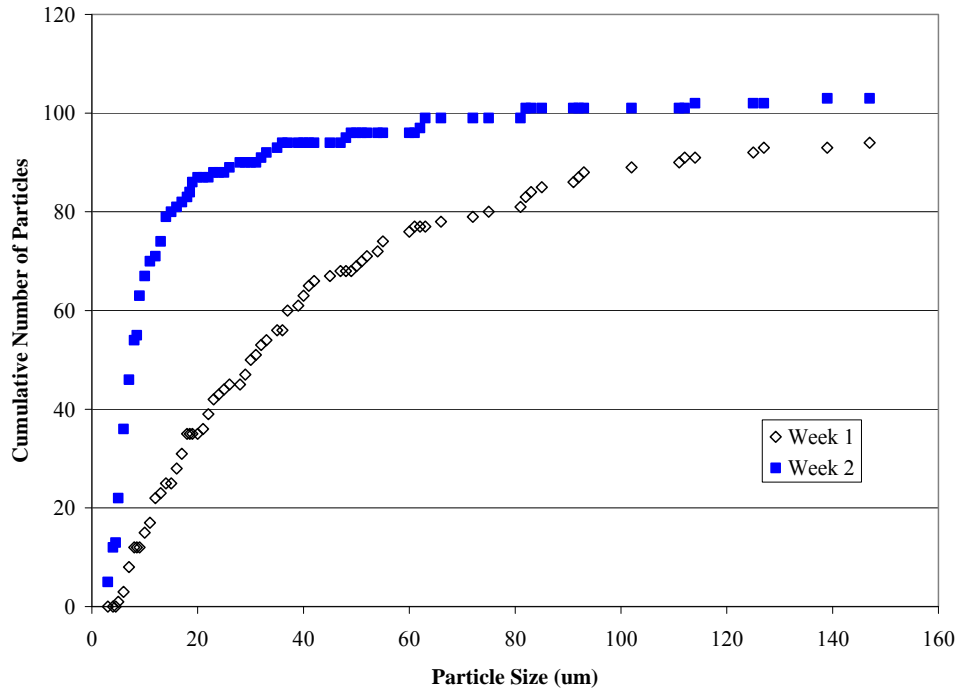

Figure 7.16. Particle Length Distribution of Sample Bottle #D_00PF1_015_XX_5675_ARC_4 (wash #13)

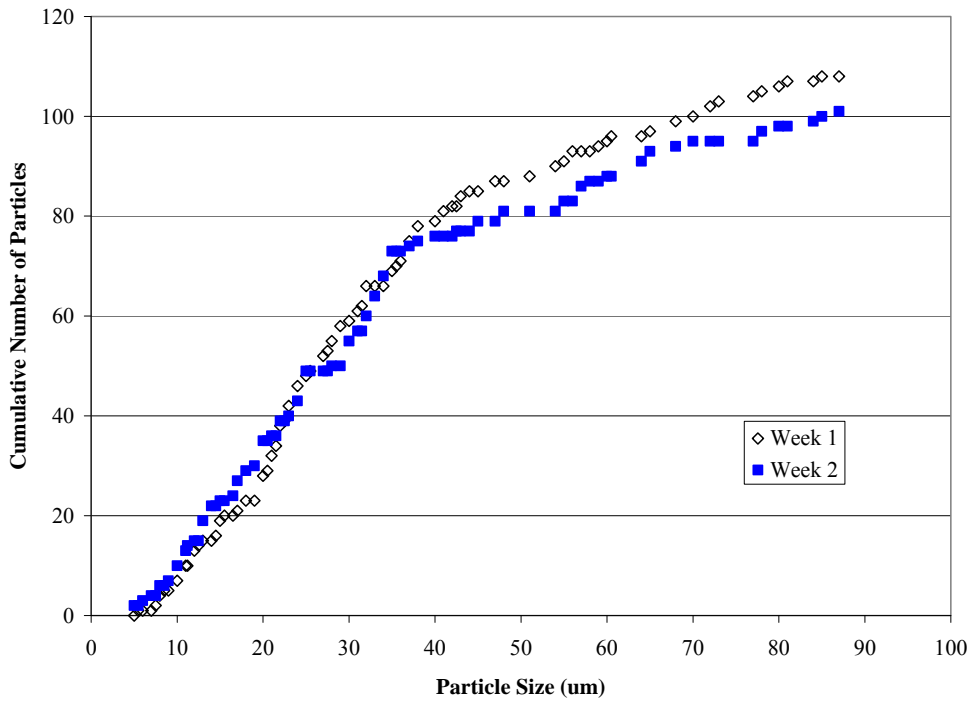

Figure 7.17. Particle Length Distribution of Sample Bottle #D_00PF1_015_XX_5476_ARC_4 (wash #40)

Table 7.3. PSD for Sample 5653

Data in mm							
Week 1 (100× and 200× magnification)					Week 2 (50× magnification)		
5653-1	5653-2	5653-3	5653-4	5653-5	5653-1	5653-2	5653-3
39	10	7	12	24	18	47	9
21	14	11	11	38	17	67	21
34	15	35	15	23	11	24	72
27	9	7	10	10	50	11	37
20	15	21	12	25	17	36	28
22	19	5	24	8	35	54	13
	17	10	21	15	9	10	30
	19	20	18	16	14	36	15
	13	5	22	24	24	19	31
	18	11	11	22	24	53	10
	25	7	18	19	65	21	48
	11	4.5	22	20	10	18	9
	22	3.5	27	10	34	19	22
	16		10	27	40	8	15
	8		6	35	36	11.5	
			27	20	16	62	
			15	35	21	20	
			15	20	75	7	
			7	19	11	17	
				57	25	32	
				20	28	17	
				20	43	44	
				16	17	35	
					17	44	
					22	56	
					40	12	
					25	9	
					14	8	
					34	19	
					11	18	
					9	13	
					20	9	
					37	13	
					49	111	
					28	22	
					13	55	
					10	44	
					14	19	

Table 7.3. PSD for Sample 5653

Data in mm							
Week 1 (100× and 200× magnification)					Week 2 (50× magnification)		
5653-1	5653-2	5653-3	5653-4	5653-5	5653-1	5653-2	5653-3
					22	22	
					14	40	
					19	14	
						8	
						14	
						52	
						19	
						21	
						10	
						19	
						16	
						13	

Table 7.4. PSD for Sample 5444

Data in mm (50× magnification)							
Week 1					Week 2		
5444-1	5444-2	5444-3	5444-4	5444-5	5444-1	5444-2	5444-3
12	14.5	8	7	6.5	28	12.5	28
23	9.5	11.5	32	16	37	26	22
15	10	14	12	7	65	15	19
17	12	73.5	17	4.5	50	62	50
12	3.5	23	17	5	23	40	24
11	41.5	7.5	20	26.5	25	60	25
12	12	31.5	54	13.5	83	31	47
17.5	17	28	22	24	71	50	22
22.5	35	21.5	27	9.5	36	58	37
20	25	46	8	26	45	42	64
26.5	32	12.5	20	8.5	42	64	39
73.5	17	46	28	17	40	42	36
11.5	81	21	13	18.5	54	30	32
20	47	6	18.5	13	44	42	72
0.42	39	10	10.5	24	23	54	115
24	64	11	24	18	27	39	75
23.5	42	42	27	66	61	58	70
20	12.5	22	21.5	32	97	57	75
33	37	18	22	13	50	32	68
25	21	12	31.5	17	72	113	12
	39		24	17.5	65	45	13
	11		13.5	14	70	60	18
			17.5	7.5	55	55	95
					48	35	55
					20	68	35
					37	35	32
					25	57	15
					71	30	38
					57	32	32
					58	23	30
					62	36	
					12	74	
					44	62	
					40	41	
					32	18	
					34		
					17		

Table 7.5. PSD for Sample 5675

Data in mm (50× magnification)									
Week 1					Week 2				
5675-1	5675-2	5675-3	5675-4	5675-5	5675-1	5675-2	5675-3	5675-4	5675-5
17	18	7	42	22	3	48	32	5	4
51	12	30	12	82	9	49	18.5	4	11
7	29	23	125	72	33	14	6	28	4
10	92	39	18	6	20	5	13	7	4
6	11	16	60	30	6	9	23	14	4
8	55	8	32	14	6	5	7	4	139
33	75	24	41	22	11	7	10	9	7
12	12	83	35	30	3	11	26	7	6
22	45	17	37	32	6	7	9	10	5
14	66	21	8	11	6	8	63	14	12
7	29	18	10	41	6	7	9	8	6
5	91	93	7		4.5	5	5	13	62
10	81	40	7		9	6	3	10	16
52	31	102	47		6	7		8	9
37	60	127	40		7	6		5	35
111	85	147	35		82	9		5	14
18	112	25	37		14			6	6
23	50	16	82		15			3	36
16	55	61			8			13	19
37	12	54			6			8.5	10
8		23			82			5	63
26					114			4	17
13					8			8	8
17								3	19
									18
									8
									7

Table 7.6. PSD for Sample 5476

Data in mm (50× magnification)									
Week 1					Week 2				
5476-1	5476-2	5476-3	5476-4	5476-5	5476-1	5476-2	5476-3	5476-4	5476-5
60.5	22.5	37	11	18	15	33	84	14	14
35	17	59	37	22	13	16.5	30	20	25
60	35	77	5.5	37	20	18	25	85	24
73	8.5	65	8	20	8	55	68	58	19
41	35	40	12	68	5	35	25	35	43
38	15	29	15.5	78	33	40	35	70	25
15	15	32	8	68	17	55	57	25	13
25.5	41	72	10	44	43	78	12	11.2	28
73	22	29	12.5	37	21	87	20	25	20
29	7.5	32	21.5	81	42	34	24	60	45
70	14.5	21	24	56	35	65	32	23	38
72	13	56	31.5	20	5	24	11	11	6
36	11	80	20	47	14		17	7	48
27	20.5	18	21.5	21	87		34	17	80
31	27.5	25	35.5	30	64		65	32	30
27	22	32	11	42.5	37		9	34	22
54	12	24	12	28	78		13	31	57
85	24	38	25	20	30		30	33	48
32	10	54	23	23	35		64	64	35
22	20	51	24	28	57		11	10	18
27		31		23	33		34	8	20
38		21		47			30	10	13
55							45	10	31
							22	32	
								22	

8.0 Cr Caustic and Oxidative Leaching Tests

Different chromium compounds leached differently, and the chromium oxyhydroxide slurry leached during the caustic leaching step of the pretreatment process, therefore not leaving enough chromium compound for the oxidative leaching step. Therefore, several different chromium compounds were examined to determine their caustic and oxidative leaching behavior to determine the best fit for the PEP simulant. These tests are discussed in this section.

The chromium oxyhydroxide slurry was eventually chosen for use in the PEP simulant. The chromium oxyhydroxide slurry (Cr-simulant) was procured separately as precipitated CrOOH slurry to be added before the oxidative leaching operation in the PEP. The production of this Cr-simulant was to be scaled up based on the initial trial batch prepared in December 2007. The scale up was to be achieved by initial production of about 15 kg of Cr ($1/3$ scale of the production batch) to verify the proposed methods to concentrate and wash the precipitate CrOOH solids. Therefore, it was necessary to establish that the Cr-simulant produced both in the small batch (15 kg of Cr) and the production batch (57 kg of Cr) exhibits similar or better leaching behavior than the initial trial batch from 2007 that used in the CUF tests during caustic and oxidative leaching operations. The objective of these tests was to provide data showing that the Cr-simulant from the larger vendor-produced batches exhibited similar or improved leaching behavior than the initial smaller trial batch during caustic and oxidative leaching operations. WTP staff were responsible for interpreting these data and for assessing the impact of the data on planned PEP operations. As such, the data are presented herein, but there is no analysis provided.

8.1 Chromium Characterization Leaching

The objective of these tests was to characterize the dissolution of the different chromium compounds obtained from different vendors during caustic leaching at 100°C and oxidative leaching at 25°C with a stirring rate of ~120 rpm. Table 8.1 identifies the manufacturer and chromium compound used in this testing. Appendix B provides the Statement of Work provided to the manufacturers (Noah Chemical and VWR) to produce the chromium hydroxide compounds for this testing. The chromium oxide obtained from Baker was laboratory-grade powder CAS No. 1308-38-9 (Lot # E41599).

These tests were performed by placing 593 g of 5 M NaOH in the test vessel. The lid was attached, and the stirring was begun at 120 rpm. It was then heated to 100°C. An initial sample was removed when it reached temperature. Then the required amount of the chromium compound was added to the vessel, and the time was recorded as zero. The actual amounts of components added are shown in Table 8.2. Samples were removed at 4 and 8 hours and filtered through a 0.45- μm syringe filter. After caustic leaching at 100°C, the batch was cooled to room temperature, and then 1 M NaMnO₄ was added to the slurries (see Table 8.2 for amount), and they were oxidatively leached for 6 hours at room temperature (~23°C). Samples were taken at 1, 2, 4, and 6 hours and filtered through a 0.45- μm syringe filter. The supernate was analyzed for CrO₄⁻ by ultraviolet-visible light (UV-Vis) spectra, and the results are shown in Table 8.3 and Table 8.4.

Table 8.1. Chromium Compound Identification

Internal Compound ID	Compound	Manufacturer
C1	Cr(OH) ₃	VWR
C2	CrOOH	Noah Chemical
C3	Cr(OH) ₃	Noah Chemical
C4	CrOOH	VWR
C5	Cr ₂ O ₃	Baker Chemical
C6	CrOOH	VWR
C7	CrOOH	Noah Chemical

Table 8.2. Amounts of Components Used in Tests

Internal Compound ID	5 M NaOH (g)	Cr Compound (g)	1 M NaMnO ₄ (mL)
C1	593.00	73.44	321
C2	593.01	40.89	305
C3	593.02	73.44	321
C4	593.01	40.89	--- ^(a)
C5	593.02	21.67	285
C6	--- ^(b)	--- ^(b)	--- ^(a)
C7	--- ^(b)	--- ^(b)	--- ^(a)

(a) An oxidative leach was not performed on this one since it had been run in the crossflow ultrafiltration system (CUF) already.

(b) These tests were performed with the complete simulant matrix for caustic leaching only.

Determining the chromate concentration in the sample for C6 by ultraviolet visible (UV-Vis) was complicated by the interference of nitrate and especially nitrite in the sample. Therefore, the data were treated in two ways. One method was to assume that all of the 372-nm absorbance was due to chromate, essentially ignoring the contribution due to nitrite. This gives a maximum estimated value for chromate (the middle column in Table 8.3.a). The other method was to assume that the 0 time had no chromate contribution to the 372-nm absorbance, and assign any 372-nm increase in later time measurements to chromate, essentially using the time 0 absorbance as a blank (the right column in Table 8.3.b).

Table 8.3.a. Cr Caustic Leaching Results from the Chromium Characterization Tests

Time (hr)	Sample ID	Test Description	[CrO ₄ ²⁻], M, < estimate	[CrO ₄ ²⁻], M, > estimate
0	CL-C6-0	Caustic leach of compound C6	1.88E-03	0.00E+00
1	CL-C6-1	Caustic leach of compound C6	2.27E-03	3.97E-04
2	CL-C6-2	Caustic leach of compound C6	2.47E-03	5.94E-04
4	CL-C6-4	Caustic leach of compound C6	2.83E-03	9.55E-04
8	CL-C6-8	Caustic leach of compound C6	3.11E-03	1.24E-03
24	CL-C6-24	Caustic leach of compound C6	4.29E-03	2.41E-03

Table 8.3.b (cont)

Time (hr)	CL-C1 [CrO ₄ ²⁻], M	CL-C2 [CrO ₄ ²⁻], M	CL-C3 [CrO ₄ ²⁻], M	CL-C4 [CrO ₄ ²⁻], M	CL-C5 [CrO ₄ ²⁻], M	CL-C7 [CrO ₄ ²⁻], M
	Caustic leach of compound C1	Caustic leach of compound C2	Caustic leach of compound C3	Caustic leach of compound C4	Caustic leach of compound C5	Caustic leach of compound C7
4	7.81E-04	9.91E-04	4.84E-04	6.81E-04	1.29E-03	8.10E-04
8	1.34E-03	1.44E-03	8.83E-04	1.20E-03	1.91E-03	1.00E-03

Table 8.4. Cr Oxidative Leaching Results from the Chromium Characterization Tests

Time (hr)	OL-C1 [CrO ₄ ²⁻], M	OL-C2 [CrO ₄ ²⁻], M	OL-C3 [CrO ₄ ²⁻], M	OL-C5 [CrO ₄ ²⁻], M
	Oxidative leach of compound C1	Oxidative leach of compound C2	Oxidative leach of compound C3	Oxidative leach of compound C5
1	3.31E-01	3.45E-01	3.79E-01	1.04E-01
2	3.63E-01	3.62E-01	3.85E-01	1.29E-01
4	3.43E-01	3.70E-01	3.79E-01	1.47E-01
6	3.40E-01	3.60E-01	3.95E-01	1.55E-01

8.2 Full Matrix Chromium Leaching Tests

The objective of these tests was to characterize the dissolution of the different chromium compounds obtained from the different vendors in the full simulant matrix during caustic leaching at 100°C with a stirring rate of ~120 rpm. Table 8.5 identifies the test identification, the chromium compound, and vendor for each test performed. Appendix B provides the Statement of Work provided to the manufacturers (Noah Chemical and VWR) to produce the chromium hydroxide compounds for this testing. The chromium oxide obtained from Baker was laboratory-grade powder CAS No. 1308-38-9 (Lot # E41599).

Table 8.5. Chromium Compound Identification for Full Matrix Testing

Internal Compound ID	Compound	Manufacturer
FMC1	Cr(OH) ₃	VWR
FMC2	CrOOH	Noah Chemical
FMC3	Cr(OH) ₃	Noah Chemical
FMC4	CrOOH Slurry	Noah Chemical
FMC5	Cr ₂ O ₃	Baker Chemical

These tests were performed by placing 264 g of iron-rich sludge slurry in the test vessel. Then 6.5 g of sodium oxalate, 57.2 g of boehmite, 57.2 g of gibbsite, and 14 g of supernate, 200.3 g of 19 M NaOH, and 199 g of DI water were added to the test vessel. The lid was attached, and the stirring began at 120 rpm. It was then heated to 100°C. An initial sample was removed when it reached temperature.

Approximately 1.9 g of the chromium compound was added to the vessel, and the time was recorded as zero. The actual amounts of components added are shown in Table 8.6. Samples (FMC) were then removed at 1, 2, 4, 8, and 24 hours and filtered through a 0.45- μ m syringe filter. The supernate was analyzed for Al, Cr, and Na by ICP-AES at SWRI, and the results are shown in Table 8.7 through Table 8.9. Then 1 M NaMnO₄ was added to the slurries (see Table 8.6 for amount), and they were oxidatively leached for 6 hours at room temperature (~23°C). Samples (FMO) were taken at 1, 2, 4, and 6 hours and filtered through a 0.45- μ m syringe filter. The supernate was analyzed for Cr by UV-Vis, and the results are shown in Table 8.10.

Table 8.6. Components Added to the Full Matrix Chromium Leaching Tests

Test ID	Fe-Rich Sludge (g)	Sodium Oxalate (g)	Boehmite (g)	Gibbsite (g)	Supernate (g)	19M NaOH (g)	DI Water (g)	Cr Compound (g)	1M NaMnO ₄ (mL)
FMC1	264.01	6.50	57.20	57.20	14.00	200.28	198.90	1.93	19
FMC2	264.02	6.50	57.20	57.20	14.01	200.28	198.92	1.93	23
FMC3	264.02	6.50	57.20	57.20	14.01	200.28	198.92	1.93	19
FMC4	264.03	6.50	57.20	57.20	14.01	200.28	198.90	1.94	23
FMC5	264.01	6.50	57.20	57.20	14.00	200.43	198.97	1.93	25

Table 8.7. Al Results from the Full Matrix Chromium Caustic Leaching Tests

Time (hr)	FMC1 (mg Al/kg soln)	FMC2 (mg Al/kg soln)	FMC3 (mg Al/kg soln)	FMC4 (mg Al/kg soln)	FMC5 (mg Al/kg soln)
0	27,000	27,000	26,900	27,600	27,200
1	26,900	26,100	26,100	27,400	27,000
2	28,200	27,800	26,400	26,800	27,200
4	26,800	26,900	26,200	27,500	27,400
8	27,100	27,800	26,400	28,700	28,800
24	30,000	27,900	26,200	29,500	30,700

Table 8.8. Cr Results from the Full Matrix Chromium Caustic Leaching Tests

Time (hr)	FMC1 (mg Cr/kg soln)	FMC2 (mg Cr/kg soln)	FMC3 (mg Cr/kg soln)	FMC4 (mg Cr/kg soln)	FMC5 (mg Cr/kg soln)
0	79.3	83.2	82.6	84.3	76.0
1	282	166	589	117	89.6
2	318	214	646	128	95.2
4	351	269	693	140	102
8	403	360	749	151	113
24	515	584	820	172	135

Table 8.9. Na Results from the Full Matrix Chromium Caustic Leaching Tests

Time (hr)	FMC1 (mg Na/kg soln)	FMC2 (mg Na/kg soln)	FMC3 (mg Na/kg soln)	FMC4 (mg Na/kg soln)	FMC5 (mg Na/kg soln)
0	85,100	85,900	84,600	84,800	84,500
1	85,200	84,900	85,000	84,200	84,700
2	86,000	87,800	85,700	85,100	85,800
4	86,500	86,200	86,500	87,600	88,100
8	88,400	87,500	87,800	89,300	90,000
24	105,000	91,500	86,500	93,700	97,300

Table 8.10. Cr Results from the Full Matrix Chromium Oxidative Leaching Tests

Time (hr)	FMO1 [CrO ₄ ²⁻] M	FMO2 [CrO ₄ ²⁻] M	FMO3 [CrO ₄ ²⁻] M	FMO4 [CrO ₄ ²⁻] M	FMO5 [CrO ₄ ²⁻] M
0	1.25E-02	1.67E-02	2.21E-02	4.61E-03	3.51E-03
1	1.70E-02	2.73E-02	2.25E-02	4.78E-03	5.89E-03
2	1.69E-02	2.88E-02	2.23E-02	4.76E-03	7.44E-03
4	1.72E-02	3.13E-02	2.22E-02	4.74E-03	1.00E-02
6	1.74E-02	3.27E-02	2.22E-02	4.75E-03	1.15E-02

8.3 Chromium Oxide Leaching Tests

The objective of these tests was to characterize the dissolution of different chromium oxide compounds obtained from different vendors during caustic leaching at 100°C and oxidative leaching at 25°C with a stirring rate of ~120 rpm. Table 8.11 identifies the manufacturer and test ID of the different compounds tested. These were technical grade chromium oxide compounds that were purchased as-is from the manufacturer.

Table 8.11. Chromium Oxide Identification

Test ID	Manufacturer
CO1	Sigma-Aldrich
CO2	Fisher Scientific
CO3	Alfa AESAR
CO4	Mallincrodt Baker
CO5	American Elements (CR-OX-02-NP)
CO6	American Elements (CR-OX-02)

These tests were performed by placing 264 g of iron-rich sludge slurry in the test vessel. Then 6.5 g of sodium oxalate, 57.2 g of boehmite, 57.2 g of gibbsite, and 14 g of supernate, 200.3 g of 19 M NaOH, and 199 g of DI water were added to the test vessel. The lid was attached, and the stirring was begun at 120 rpm. It was then heated to 100°C. An initial sample was removed when it reached temperature. Approximately 1.9 g of the chromium compound was added to the vessel, and the time was recorded as

zero. The actual amounts of components added are shown in Table 8.12. Samples were then removed at 1, 2, 4, 8, and 24 hours and filtered through a 0.45- μ m syringe filter. The supernate was analyzed for Al, Cr, and Na by ICP-AES at SWRI, and the results are shown in Table 8.13 through Table 8.15. Then 1 M NaMnO₄ was added to the slurries (see Table 8.12 for amount), and they were oxidatively leached for 6 hours at room temperature (~23°C). Samples were taken at 1, 2, 4, and 6 hours and filtered through a 0.45- μ m syringe filter. The supernate was analyzed for Al, Cr, and Na by ICP-AES, and the results are shown in Table 8.16 through Table 8.18. Test ID CL indicates caustic leaching, and OL indicates oxidative leaching.

Table 8.12. Components Added to the Chromium Oxide Leaching Tests

Test ID	Fe-Rich Sludge (g)	Sodium Oxalate (g)	Boehmite (g)	Gibbsite (g)	Supernate (g)	19M NaOH (g)	DI Water (g)	Cr Compound (g)	1M NaMnO ₄ (mL)
CO1	264.0	6.5	57.2	57.2	14.0	200.3	198.9	1.93	25
CO2	264.0	6.5	57.2	57.2	14.0	200.3	198.9	1.92	25
CO3	264.0	6.5	57.2	57.2	14.0	200.3	198.9	1.93	25
CO4	264.00	6.50	57.20	57.20	14.01	200.28	198.91	1.93	25
CO5	264.02	6.50	57.20	57.20	14.05	200.27	198.89	1.93	25
CO6	264.01	6.50	57.20	57.21	14.03	200.26	198.91	1.93	25

Table 8.13. Al Results from the Chromium Oxide Caustic Leaching Tests

Time (hr)	CL-CO1 (mg Al/kg soln)	CL-CO2 (mg Al/kg soln)	CL-CO3 (mg Al/kg soln)	CL-CO4 (mg Al/kg soln)	CL-CO5 (mg Al/kg soln)	CL-CO6 (mg Al/kg soln)
0	26,300	25,500	26,500	25,800	26,500	25,300
1	25,500	26,000	26,700	24,800	25,000	24,600
2	27,300	26,000	26,500	25,500	25,000	25,100
4	26,000	26,200	26,100	25,100	26,200	25,100
8	26,800	26,600	27,400	26,400	27,100	27,500
24	26,400	28,000	29,100	No sample	No sample	24,700

Table 8.14. Cr Results from the Chromium Oxide Caustic Leaching Tests

Time (hr)	CL-CO1 (mg Cr/kg soln)	CL-CO2 (mg Cr/kg soln)	CL-CO3 (mg Cr/kg soln)	CL-CO4 (mg Cr/kg soln)	CL-CO5 (mg Cr/kg soln)	CL-CO6 (mg Cr/kg soln)
0	77.0	77.3	77.3	77.2	82.2	82.3
1	92.1	88.9	92.0	84.7	87.1	89.8
2	101	94.2	94.9	88.7	90.6	91.5
4	104	99.1	99.8	92.3	96.5	94.2
8	113	107	108	96.7	101	101
24	125	123	124	No sample	No sample	104

Table 8.15. Na Results from the Chromium Oxide Caustic Leaching Tests

Time (hr)	CL-CO1 (mg Na/kg soln)	CL-CO2 (mg Na/kg soln)	CL-CO3 (mg Na/kg soln)	CL-CO4 (mg Na/kg soln)	CL-CO5 (mg Na/kg soln)	CL-CO6 (mg Na/kg soln)
0	84,200	85,200	85,200	83,300	84,200	85,100
1	85,300	86,300	86,800	83,100	83,500	83,500
2	87,500	86,500	86,300	83,300	85,200	84,400
4	86,300	87,000	88,000	82,200	84,400	84,100
8	87,400	89,200	89,600	82,800	86,400	86,400
24	87,500	94,900	93,600	No sample	No sample	83,100

Table 8.16. Al Results from the Chromium Oxide Oxidative Leaching Tests

Time (hr)	OL-CO1 (mg Al/kg soln)	OL-CO2 (mg Al/kg soln)	OL-CO3 (mg Al/kg soln)	OL-CO4 (mg Al/kg soln)	OL-CO5 (mg Al/kg soln)	OL-CO6 (mg Al/kg soln)
0	28,100	30,200	29,700	26,900	28,900	28,600
1	26,300	28,400	28,900	24,400	27,100	28,100
2	27,300	27,900	28,200	24,900	27,100	27,100
4	26,000	28,300	28,600	24,300	28,000	26,800
6	26,200	28,100	28,600	25,700	29,200	26,700

Table 8.17. Cr Results from the Chromium Oxide Oxidative Leaching Tests

Time (hr)	OL-CO1 (mg Cr/kg soln)	OL-CO2 (mg Cr/kg soln)	OL-CO3 (mg Cr/kg soln)	OL-CO4 (mg Cr/kg soln)	OL-CO5 (mg Cr/kg soln)	OL-CO6 (mg Cr/kg soln)
0	125	124	121	105	121	120
1	146	133	127	106	126	120
2	169	136	128	107	140	121
4	190	151	133	110	162	124
6	217	165	139	109	182	127

Table 8.18. Na Results from the Chromium Oxide Oxidative Leaching Tests

Time (hr)	OL-CO1 (mg Na/kg soln)	OL-CO2 (mg Na/kg soln)	OL-CO3 (mg Na/kg soln)	OL-CO4 (mg Na/kg soln)	OL-CO5 (mg Na/kg soln)	OL-CO6 (mg Na/kg soln)
0	85,600	91,900	93,400	78,900	91,900	91,800
1	83,300	87,800	90,500	79,500	89,100	88,200
2	85,500	87,600	89,600	79,500	88,500	88,100
4	82,800	88,900	90,700	79,200	88,300	88,200
6	82,600	87,400	90,000	78,900	89,100	88,200

8.4 Chromium Oxidative Leach Investigation Tests

The objective of these tests was to investigate the dissolution of different chromium compounds under different conditions during oxidative leaching at 25°C with a stirring rate of ~120 rpm. Each chromium compound used is listed in Table 8.19. Appendix B provides the Statement of Work provided to the manufacturers to produce the chromium hydroxide compounds for this testing. The chromium oxide compounds were just technical grade that were purchased from the manufacturer's catalog.

These tests were performed in a variety of ways. The amounts used for each test are shown in Table 8.20. The first test (CLI1) was performed by mixing boehmite, gibbsite, sludge slurry, sodium oxalate, chromium oxide, supernate, DI water, and 19 M NaOH together in the test vessel. Then it was centrifuged and the supernate decanted. The remaining solids were washed three times with 0.01 M NaOH and centrifuged and decanted each time. The washed slurry was placed back into the test vessel and 5 M NaOH and 1 M NaMnO₄ were added. The test was run for 6 hours with samples taken at 1, 2, 4, and 6 hours.

The second test (CLI2) was performed by placing 500-mL of 0.25 M NaOH in the test vessel and adding 1.93 g Cr₂O₃. Then 25-mL of 1 M NaMnO₄ was added, and the test was run for 6 hours with samples taken at 1, 2, 4, and 6 hours.

The rest of the tests (CLI4a, CLI4b, and CLI5) were performed the same way as the first one by mixing boehmite, gibbsite, sludge slurry, sodium oxalate, supernate, DI water, and 19 M NaOH together in the test vessel, but using different chromium sources. It was then heated to 100°C. After reaching temperature, the chromium compound was added, and samples were removed at 0, 1, 2, 4, 8, and 24 hours. The slurry was cooled, centrifuged, decanted, and washed three times with 0.01 M NaOH, centrifuging and decanting each time. The washed slurry was placed back into the test vessel and 5 M NaOH and 1 M NaMnO₄ were added. The test was then run for 6 hours at room temperature (~23°C) with samples taken at 1, 2, 4, and 6 hours. The supernate from both the caustic and oxidative leaches was analyzed for Cr by UV-Vis, and the results are shown in Table 8.21 and Table 8.22.

Table 8.19. Chromium Investigative Leach Test Compound Identification

Test ID	Manufacturer
CLI1	Sigma-Aldrich Cr ₂ O ₃
CLI2	Sigma-Aldrich Cr ₂ O ₃
CLI4a	Noah CrOOH
CLI4b	VWR CrOOH
CLI5	Sigma-Aldrich Cr ₂ O ₃

Table 8.20. Components Added to the Chromium Investigative Leach Tests

Test ID	Fe-Rich Sludge (g)	Sodium Oxalate (g)	Boehmite (g)	Gibbsite (g)	Supernate (g)	19 M NaOH (g)	DI Water (g)	Cr Compound (g)	NaOH	1 M NaMnO ₄ (mL)
CLI1	264.01	6.50	57.20	57.20	13.99	200.28	198.92	1.93	36.7 g (5 M)	25
CLI2	--	--	--	--	--	--	--	1.93	500-mL (0.25 M)	25
CLI4a	247.33	15.60	54.10	54.10	17.01	200.26	198.91	12.51	48.6 g (5 M)	25
CLI4b	247.30	15.60	54.10	54.10	17.01	200.27	198.89	12.51	48.6 g (5 M)	25
CLI5	247.31	15.60	54.10	54.12	17.00	200.27	198.91	1.93	48.6 g (5 M)	25

Table 8.21. Cr Results from the Chromium Investigative Caustic Leach Tests

Time (hr)	CLI4a [CrO ₄ ²⁻] M	CLI4b [CrO ₄ ²⁻] M	CLI5 [CrO ₄ ²⁻] M
0	1.78E-03	1.87E-03	1.89E-03
1	1.06E-02	1.19E-02	2.27E-03
2	1.38E-02	1.51E-02	2.37E-03
4	1.74E-02	1.81E-02	2.40E-03
8	2.04E-02	2.06E-02	2.56E-03
24	2.95E-02	2.81E-02	2.87E-03

Table 8.22. Cr Results from the Chromium Investigative Oxidative Leach Tests

Time (hr)	CLI1 [CrO ₄ ²⁻] M	CLI2 [CrO ₄ ²⁻] M	CLI4a [CrO ₄ ²⁻] M	CLI4b [CrO ₄ ²⁻] M	CLI5 [CrO ₄ ²⁻] M
0	1.25E-04	3.05E-05	3.74E-03	2.41E-03	1.56E-04
1	2.35E-03	4.75E-03	3.91E-02	3.48E-02	1.08E-03
2	3.08E-03	7.86E-03	3.85E-02	3.64E-02	1.33E-03
4	4.20E-03	1.16E-02	3.92E-02	3.67E-02	1.62E-03
6	5.73E-03	1.32E-02	3.88E-02	3.64E-02	1.91E-03

9.0 References

Huckaby JL and JR Markillie. 2008. *Pretreatment Engineering Platform (PEP) Testing (Phase I)*. WTP Project Doc. No. 24590-PTF-TSP-RT-07-001, Rev. 2.

Mahoney LA, SD Rassat, PW Eslinger, RL Aaberg, PM Aker, EC Golovich, TS Hausmann, DE Kurath, SK Sundaram, and ST Yokuda. 2009. *EFRT Issue Resolution: Caustic Leach Rate Constants from PEP and Lab-Scale Tests*. WTP-RPT-186, Rev. 0, PNNL-18502, Pacific Northwest National Laboratory, Richland Washington.

Rapko BM, JR Deschane, GJ Lumetta, and RA Peterson. 2007. *Process Development for Permanganate Addition During Oxidative Leaching of Hanford Tank Sludge Simulants*. WTP-RPT-164, Rev. 0, PNNL-16794, Pacific Northwest National Laboratory, Richland Washington.

Rapko BA, C Brown, PW Eslinger, MS Fountain, TS Hausmann, and DE Kurath. 2009. *EFRT Issue Resolution: Comparison of PEP and Bench-Scale Oxidative Leaching Results*. WTP-RPT-188, Rev. 0, PNNL-18500, Pacific Northwest National Laboratory, Richland Washington.

Russell RL, RA Peterson, HD Smith, DE Rinehart, PM Aker, and EC Buck. 2009a. *Development and Characterization of Boehmite Component Simulant*. WTP-RPT-184, Rev. 1, PNNL-18176, Pacific Northwest National Laboratory, Richland, Washington.

Russell RL, HD Smith, DE Rinehart, and RA Peterson. 2009b. *Development and Characterization of Gibbsite Component Simulant*. WTP-RPT-176, Rev. 0, PNNL-18013, Pacific Northwest National Laboratory, Richland, Washington.

Russell RL, JM Billing, RA Peterson, DE Rinehart, and HD Smith. 2009c. *Development and Demonstration of Ultrafiltration Simulants*. WTP-RPT-184, Rev. 0, PNNL-18090, Pacific Northwest National Laboratory, Richland, Washington.

Appendix A

Boehmite Dissolution Model

Appendix A: Boehmite Dissolution Model

Note: This model has been submitted to the International Journal of Chemical Engineering but has not been accepted as of yet.

Boehmite Dissolution Model Based on Simulant Data

ABSTRACT

Several of the Hanford waste tanks contain significant quantities of boehmite. This boehmite will be dissolved through caustic leaching as part of the Hanford Tank Waste Treatment and Immobilization Plant (WTP) currently under construction. Therefore, it is important to fully understand the nature of this dissolution process so that caustic leaching can be effectively deployed on the Hanford tank wastes.

This research determined the impact of primary control parameters such as temperature, hydroxide concentration, approach to solubility, and stirring rate on the boehmite dissolution rate. The impact of aluminate ion on the dissolution kinetics was also determined. In addition, other parameters that impact boehmite dissolution, such as free-hydroxide concentration and reaction temperature, were also assessed and used to develop a semi-empirical model of the boehmite dissolution process. The understanding derived from this work will be used as the basis to evaluate and improve the planned performance of aluminum leaching during waste pretreatment while preparing to vitrify waste in the WTP.

This work is the first in a series of programs aimed at demonstrating the WTP waste pretreatment leaching process. This work was used to develop a simulant of the boehmite-containing Hanford waste. That simulant is subsequently being used in laboratory- and pilot-scale testing to demonstrate the WTP pretreatment process in an integrated fashion.

Introduction

During the historical production of Pu at the Hanford Site from 1944 to the early 1970s, a significant volume of high-level waste (HLW) sludge was produced and stored in tanks at the Hanford Site. The Hanford Waste Tank Treatment and Immobilization Plant (WTP) under construction on the Hanford Site will be designed to separate the waste into two fractions for immobilization. After the HLW is separated from the low-activity waste (LAW) liquid stream by ultrafiltration in the Pretreatment Facility (PTF), the concentrated HLW will undergo caustic and oxidative leaching processes to dissolve and wash out materials (aluminum, chromium, phosphates, and sulfates) that would otherwise limit HLW loading in the glass waste form. The concentrated HLW solids will be sequentially caustic leached, washed, oxidatively leached, and washed once more during pretreatment. Caustic leaching dissolves the aluminum in the HLW solids, and then oxidative leaching is used to oxidize the chromium with a sodium permanganate (NaMnO_4) solution and dissolve it in a mild caustic solution. The HLW solids are concentrated after each leaching and washing operation using cross-flow ultrafiltration.

Caustic-leaching experiments were first performed on actual Hanford tank sludge samples in Fiscal Year (FY) 1993. The original caustic-leaching experiments were a prelude to dissolving sludge solids with acid so the acid-dissolved fraction could be processed through solvent extraction. This separates the very small mass fraction of the radioactive elements (the transuranics [TRUs], ^{90}Sr , and ^{137}Cs) from the

bulk mass of non-radioactive components (Lumetta et al. 1996). In this respect, caustic leaching was meant to remove the large amount of aluminum from the waste, thus reducing the nitric acid demand and simplifying the solvent extraction feed. Subsequently, caustic leaching (sometimes referred to as “Enhanced Sludge Washing”) was chosen as the baseline method for Hanford tank sludge pretreatment (Lumetta et al. 1998). Following this decision, caustic-leaching tests were performed under a standard set of conditions at Pacific Northwest National Laboratory (PNNL) and Los Alamos National Laboratory from FY 1994 through FY 1997 (Lumetta et al. 1996, 1997; Rapko et al. 1995; Willingham 1994; Temer and Villarreal 1995, 1996, 1997). In subsequent years, a limited number of parametric caustic-leaching experiments were performed at PNNL and also at Oak Ridge National Laboratory (Lumetta et al. 1998; Palmer et al. 2000; Lumetta et al. 2001; Brooks et al. 1998). After establishing the Hanford WTP project, a limited number of laboratory-scale caustic-leaching experiments were performed using a standard testing protocol (Brooks et al. 2000a, 2000b; Poirier et al. 2003; Russell et al. 2009), but these were generally focused on processing double-shell tank wastes rather than the single-shell tanks where the bulk of the sludge is stored. More recent tests have focused on blends of samples from the single-shell tanks. These tests focused on evaluating the performance of specific chemical species during the caustic-leaching process.

Caustic-leaching data are needed on the various types of wastes to be processed through the WTP to support the plant design. The data needed include 1) dissolution kinetics of key HLW sludge components (e.g., Al, Cr, P, and S) as a function of caustic concentration, temperature, and time, 2) the behavior of radionuclides during the leaching process, 3) particle-size distribution before and after leaching, and 4) the identification of the chemical and mineral forms of important sludge components (e.g., Al, Cr, and P) in the sludge solids. These data will be used to update the assessments of the expected performance of the WTP pretreatment process and to support the development of various waste simulants for scaled process demonstrations.

Aluminum in the wastes is believed to be present in the two most common mineralogical phases: gibbsite (monoclinic $\text{Al}(\text{OH})_3$) and boehmite (orthorhombic AlOOH). Other Al-containing phases include bayerite, dawsonite, alumina silicates, and amorphous aluminum hydroxide. The dissolution rates of the two primary mineralogical phases are considerably different (Music et al. 1998). Therefore, the leaching kinetics will depend on the relative amounts of these phases in the waste as well as particle size, crystal habit (i.e., particle size and shape), operating temperature, hydroxide activity, aluminum solubility limits, particle Reynolds number associated with the mixing system, etc. The other aluminum compounds in the waste solids are present in relatively smaller amounts and therefore are considered less significant to the caustic leaching for removing aluminum from the HLW.

This appendix describes and evaluates a series of characterization tests that have quantified the various types of aluminum present in the Hanford HLW (Fiskum et al. 2008). Table 1 shows a breakdown of the Al sources in Hanford HLW. Values are shown in terms of the mass of aluminum associated with each phase. The figure indicates that most of the aluminum is either sodium aluminate (supernate and water soluble) or gibbsite. The next major component is boehmite. The boehmite represents the largest component for which aggressive leaching conditions are required to achieve dissolution. As such, understanding the boehmite leaching chemistry and the impacts on the WTP flowsheet using a boehmite simulant will be critical to the WTP performance.

Table 1. Sources of Al in Hanford Tank Waste

Al Source	Metric Tons of Al
Supernate	1,188
Water Soluble	1,297
Easy to Dissolve	306
Gibbsite	3,022
Boehmite	1,775
Unassigned	568
Intractable	552
Total	8,708

A number of studies of boehmite dissolution have been performed in the past (Palmer et al. 2000; Packter 1976; Palmer et al. 2001; Panias 2004). In addition, a number of studies have investigated precipitation kinetics for boehmite (Panias 2004; Skoufadis et al. 2003; Dash et al. 2009). The dissolution studies have indicated, as expected, that the dissolution kinetics are a strong function of both temperature and hydroxide concentration. Packter measured an activation energy for boehmite dissolution between 115 and 125 kJ/mole. Palmer found that the presence of nitrate appeared to suppress the dissolution of boehmite. Note, however, that none of these studies evaluated the impact of the presence of aluminate ion on the dissolution rate.

Experimental

This section describes the methods used to conduct the leach testing for both actual waste samples and simulant samples. The data results for the simulant samples are presented in Sections 4 and 5 of the main body of this report.

Boehmite was obtained from APYRAL (for product information, see: Appendix C, product AOH 20), product AOH 20. X-ray diffraction (XRD) analysis confirmed that this material is boehmite. The tests were performed in a 1-L reaction vessel as shown in Figure 1. The vessel was filled with the leaching fluid and heated to the leaching temperature. The temperature was measured with a calibrated thermocouple (TC) and controlled with a calibrated temperature controller. Boehmite was added as a powder to the reaction vessel through the sample port while stirring after the leaching fluid had reached leaching temperature, which started the clock for the test. The test solution was sampled at 1, 2, 4, 8, and 24 hours. Each sample consisted of 5-mL supernatant, which was filtered through a 0.45- μm filter after being drawn from the reaction vessel and then analyzed for aluminum and sodium content by inductive coupled plasma-atomic emission spectroscopy (ICP-AES). The amount of aluminate was adjusted by dissolving gibbsite before introducing the boehmite. The amount of gibbsite added is reflected in the initial aluminate concentration at time 0 for each test.

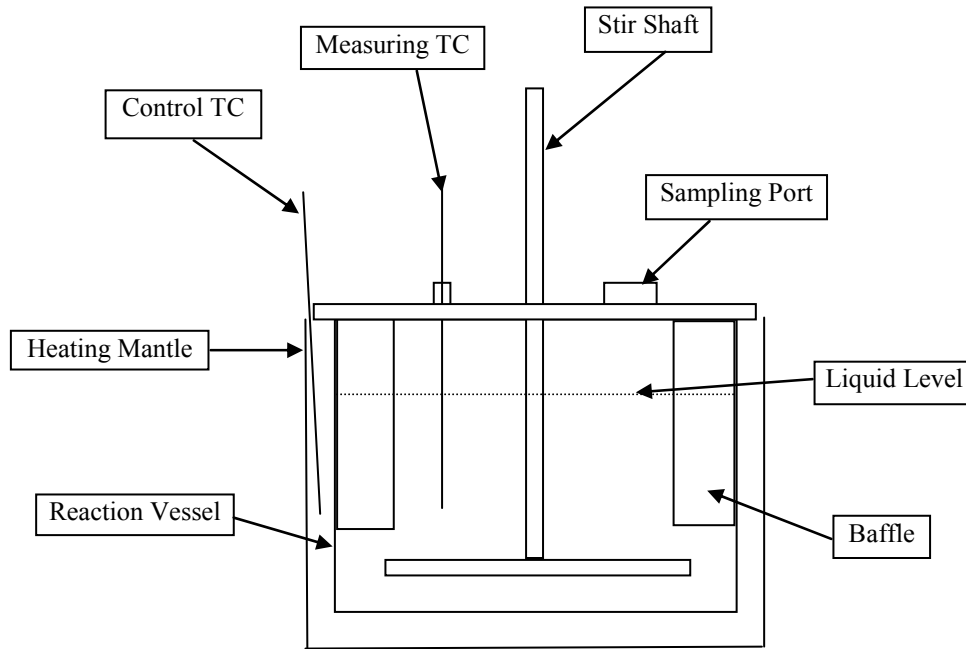
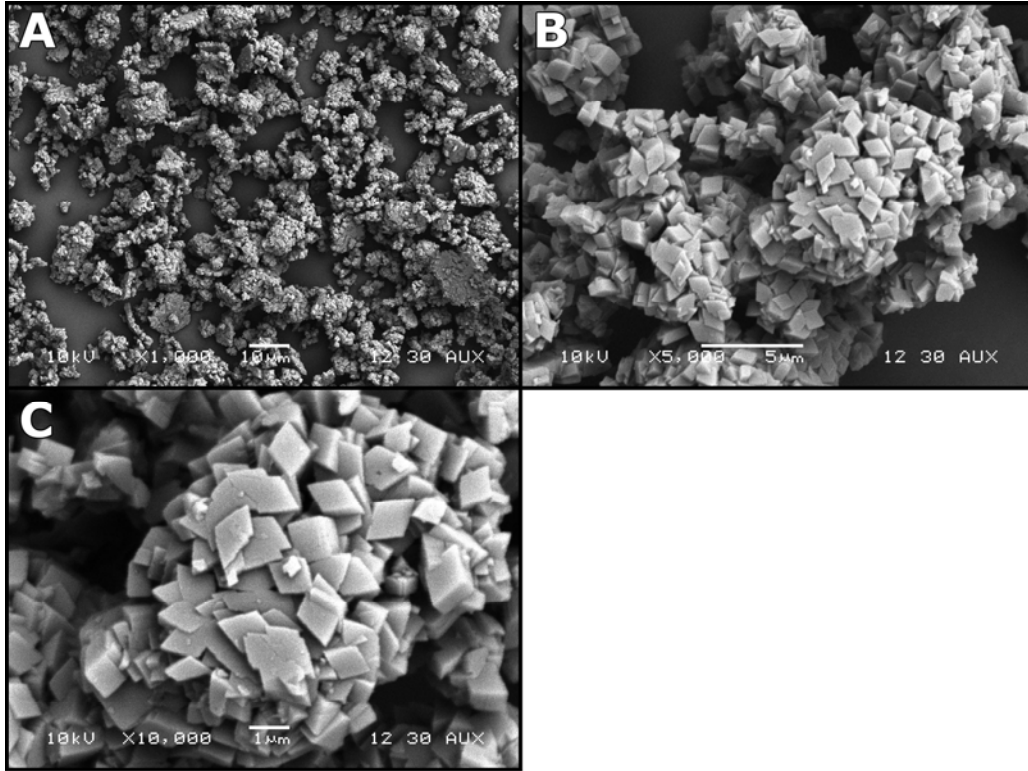

Figure 1. Schematic Drawing of the Caustic Leaching Test Setup

Results

Sample Characterization

Figure 2 shows a scanning electron microscopy (SEM) micrograph of the commercially procured boehmite that was used in the simulant tests. Note that the average crystal size for this material is approximately 0.8 microns. The material agglomerates into larger particles, so particle-size distribution measurements do not provide significant insight into the reactivity of the boehmite.



SEM micrographs of B3 APYRAL AOH 20 . Average Particle Size of 0.83 μm.

Figure 2. SEM Micrograph of the Boehmite to Be Used in the Simulant

Table 2 compares the surface area of the actual tank waste sample to that of the boehmite used in these tests. As might be expected from the smaller primary particle size, the surface area of the actual tank waste material was significantly larger than for the commercially procured boehmite.

Table 2. Surface Area of Boehmite Samples

Sample ID	Specific Surface Area (m ² /g)
Washed Tank Waste Solids	26
Simulant Boehmite	10

Aluminum Dissolution Studies

The dissolution of boehmite is generally expressed as:



At a given condition, this can be written as

$$\frac{dAlOOH}{dt} = -k_f(OH)^- + k_r Al(OH)_4^- \quad (\text{Eq. 2})$$

where k_f includes a surface area term associated with the boehmite surface. At saturation, this can be written as

$$\frac{dAlOOH}{dt} = 0 \therefore k_f (OH)_s^- = k_r Al(OH)_{4,s}^- \quad (\text{Eq. 3})$$

where s represents the concentration at the solubility limit. Substituting produces:

$$\frac{dAlOOH}{dt} = -k_f (OH)^- + k_f \frac{(OH)_s^-}{Al(OH)_{4,s}^-} Al(OH)_4^- \quad (\text{Eq. 4})$$

If we assume a relatively large excess of total hydroxide:

$$\frac{dAlOOH}{dt} = -k_f (OH)^- \left(1 - \frac{Al(OH)_4^-}{Al(OH)_{4,s}^-} \right) \quad (\text{Eq. 5})$$

or

$$\frac{dAlOOH}{dt} = -k_f (OH)^- (1 - \sigma) \quad (\text{Eq. 6})$$

where

$$\sigma = \frac{Al(OH)_4^-}{Al(OH)_{4,s}^-} \quad (\text{Eq. 7})$$

then, adding the surface-area dependence

$$\frac{dAlOOH}{dt} = -k A_B (OH)^- (1 - \sigma) \quad (\text{Eq. 8})$$

where, based on a shrinking core model (Pereira et al. 2009) where i indicates the initial concentration:

$$A_B \propto AlOOH^{2/3} \quad (\text{Eq. 9})$$

$$\frac{A_B}{A_{B,i}} = \left(\frac{AlOOH}{AlOOH_i} \right)^{2/3} \quad (\text{Eq. 10})$$

$$\frac{d \left(\frac{AlOOH}{AlOOH_i} \right)}{dt} = -k \left(\frac{AlOOH}{AlOOH_i} \right)^{2/3} (OH)^- (1 - \sigma) \quad (\text{Eq. 11})$$

A set of tests was performed where the initial matrix contained varying amounts of dissolved sodium aluminate. In these tests, the initial supernate contained various levels of soluble aluminate before the start of leaching. The results from these tests are plotted in Figure 3 as a function of the Al concentration

normalized with Na to the average value in solution over time at 100°C. Figure 3 shows that the boehmite dissolves more slowly when more Al is in the solution. Note that while Equation 11 provides a reasonable fit to the experimental data, it appears to under-predict the impact of the initial aluminate concentration on the reaction rate. This is evidenced by the fact that the model under-predicts at low aluminate and appears to over-predict at high aluminate. This indicates that the dissolution model should be revised. One form that was tested and found to be statistically superior was to include a term for the initial aluminate concentration shown in Equation 12.

$$\frac{d\left(\frac{AlOOH}{AlOOH_i}\right)}{dt} = -k\left(\frac{AlOOH}{AlOOH_i}\right)^{2/3} (OH)^-(1-\sigma)(1-\sigma_i) \quad (\text{Eq. 12})$$

This revised model provides a statistically improved fit to the data as seen in Figure 4. As seen, this revised model now provides more accurate predictions over the entire range of initial aluminate concentrations. Note that simply squaring the last term in Equation 11 did not provide the same fit to the experimental data in that it again led to under-prediction of the reaction rate at low initial aluminate concentrations.

To fit to the 85°C data (Figure 5), a temperature correction term is needed. From this data, it was determined that there is a 120-kJ activation energy associated with Equation 13. The data in Figure 5 were used to derive this activation energy. Then the resultant model with the temperature correction included was applied to the data over a range of temperatures and is shown in Figure 6.

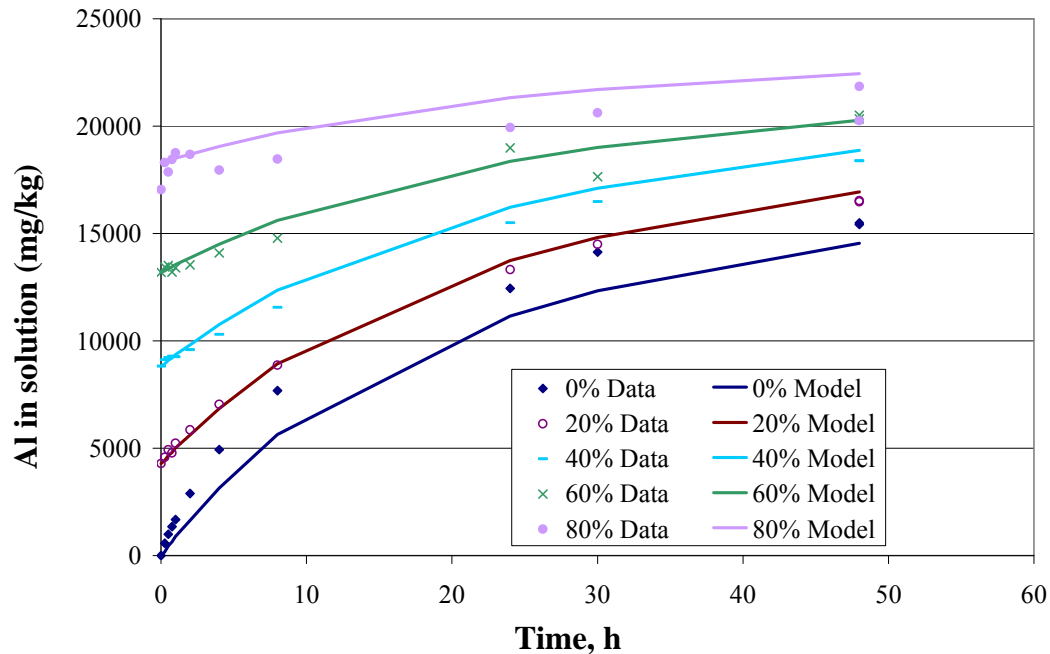

Figure 3. Boehmite Dissolution with Aluminate Present Fit to the Model as Expressed by Eq. 11

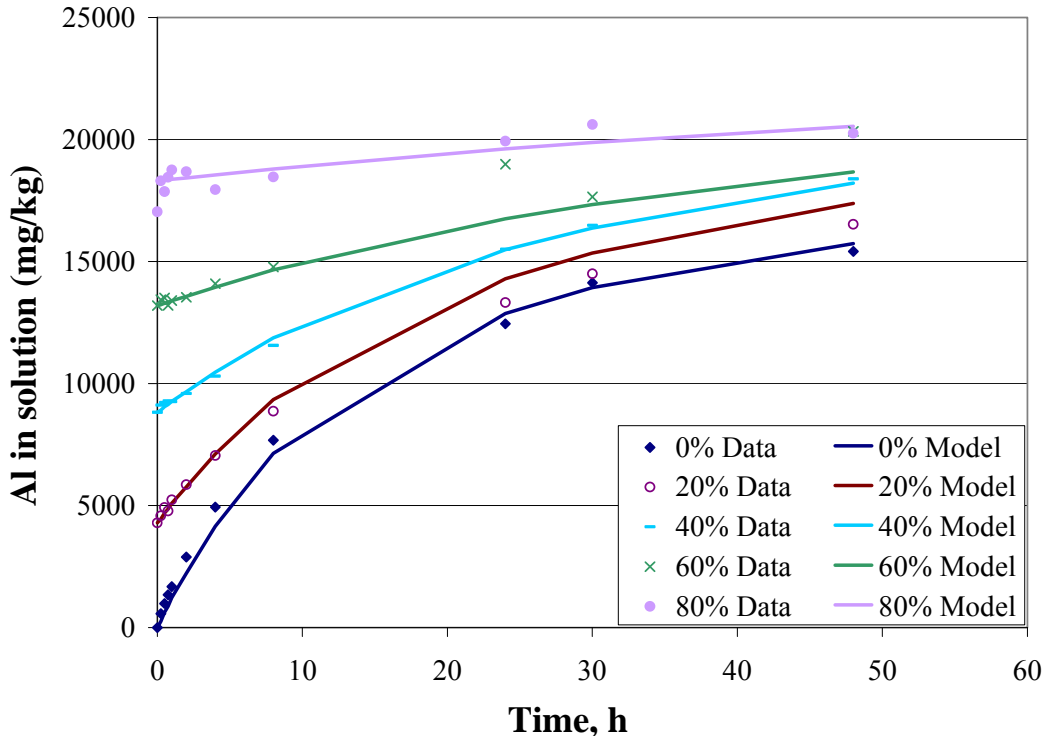

Figure 4. Boehmite Dissolution with Aluminate Present Fit to the Revised Model as Expressed by Eq. 12

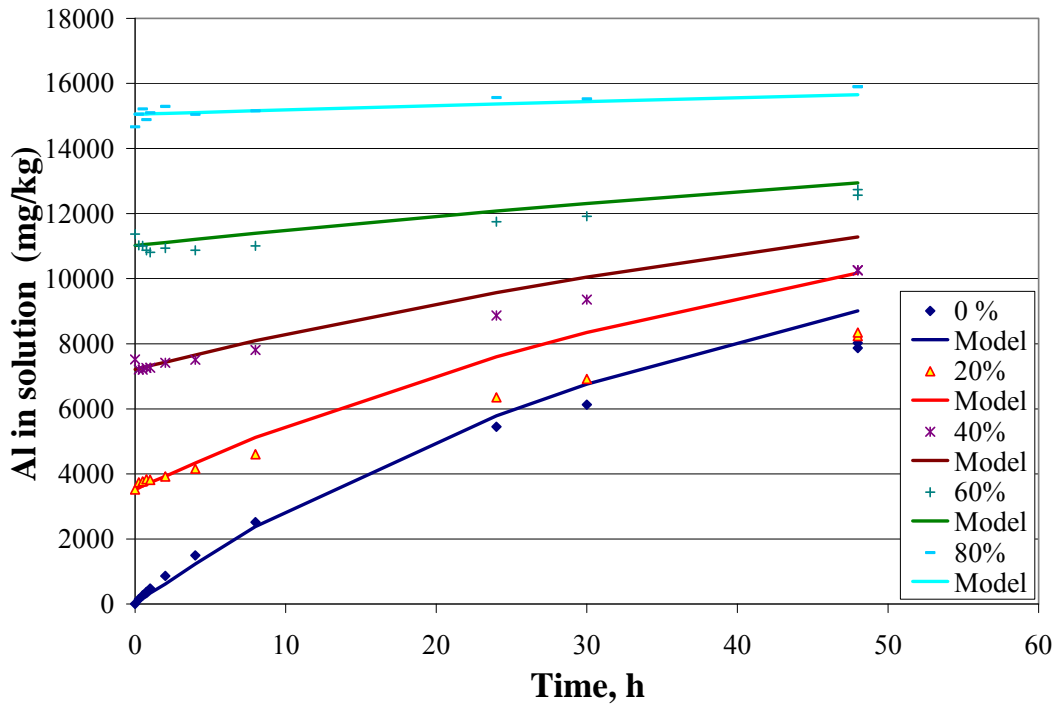

Figure 5. Boehmite Dissolution at 85°C Fit to the Model as Expressed by Eq. 13

$$\frac{d\left(\frac{AlOOH}{AlOOH_i}\right)}{dt} = -A_o e^{-\frac{120,000}{RT}} \left(\frac{AlOOH}{AlOOH_i}\right)^{2/3} (OH)^-(1-\sigma)(1-\sigma_i) \quad (\text{Eq. 13})$$

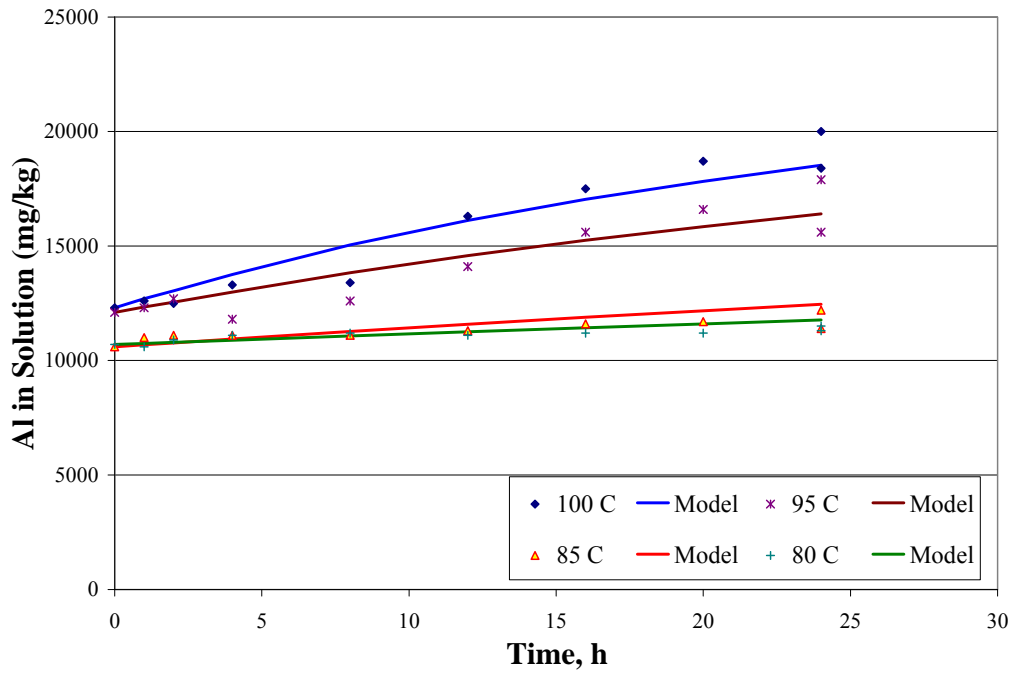

Figure 6. Results from 80°C to 100°C with Temperature Correction as Expressed by Eq. 13

The impact of varying amounts of gibbsite on boehmite dissolution was evaluated with the derived model. Figure 7 shows a plot of the time necessary to achieve 50% boehmite dissolution as a function of the Na:Al molar ratio. These results show that the presence of gibbsite requires either more caustic or more time to achieve the same fraction of boehmite dissolved.

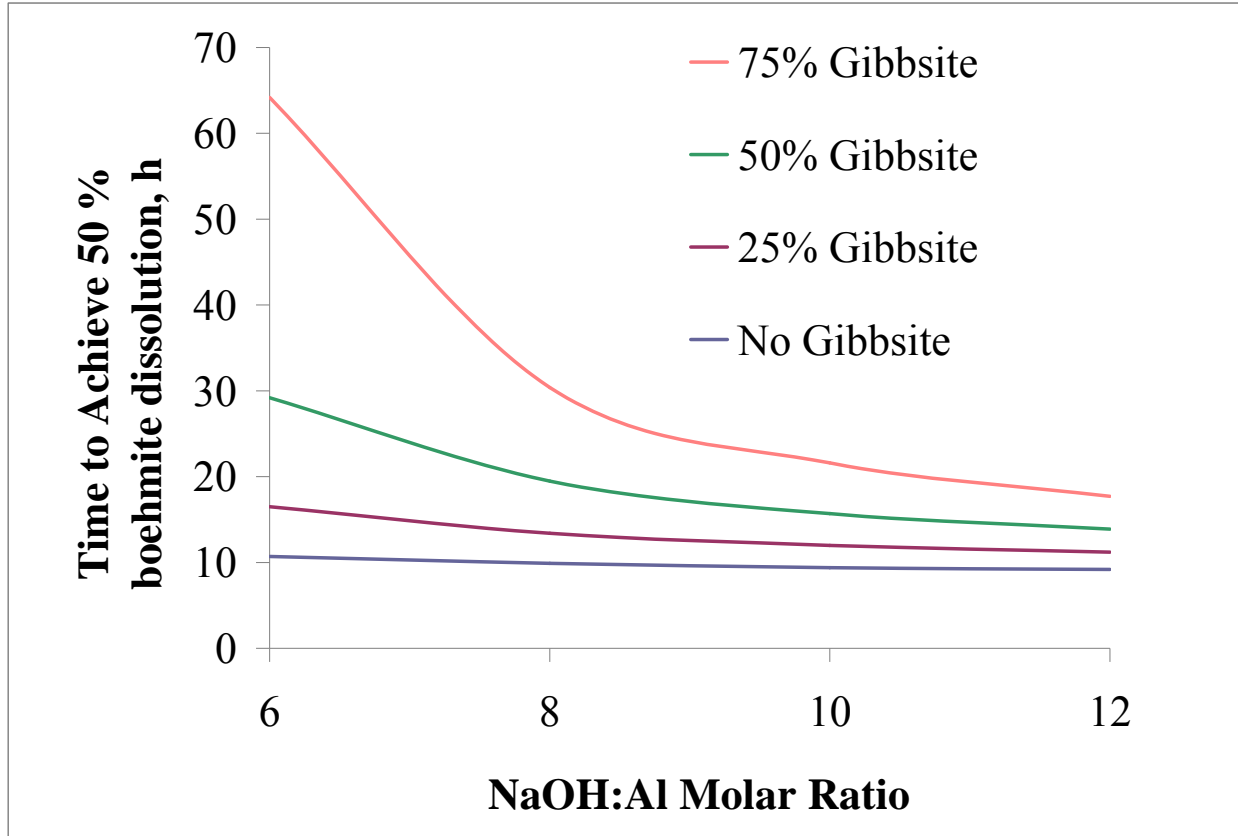

Figure 7. Impact of Fraction of Aluminum as Gibbsite on Boehmite Dissolution for Various Ratios of NaOH to Total Insoluble Al

Conclusions

A shrinking core model was used to fit data from a series of boehmite dissolution tests. An additional term was added to the shrinking core model to account for the approach to saturation. This revised model provided an adequate fit to the experimental data; however, a superior fit to the experimental data was obtained when a term was added to represent the number of dissolution sites available at the start of the reaction as shown in the following equation:

$$\frac{d\left(\frac{AlOOH}{AlOOH_i}\right)}{dt} = -A_o e^{-\frac{120,000}{RT}} \left(\frac{AlOOH}{AlOOH_i}\right)^{2/3} (OH)^-(1-\sigma)(1-\sigma_i) \quad (14)$$

These results suggest that boehmite will dissolve significantly slower as gibbsite dissolves and adds aluminate to the solution. Practically, these results indicate that the blending wastes with gibbsite and boehmite will ultimately result in either more caustic or more time to achieve the same fraction of boehmite dissolution. For the proposed dissolution process, blending strategies must consider the trade-offs between caustic usage, processing time, and time to prepare feed.

ACKNOWLEDGEMENTS

We would like to acknowledge Don Rinehart for all of his lab work in performing the tests and Brian Riley for his SEM work. We would also like to acknowledge Bechtel National, Inc. for funding this work.

References

- Brooks, K. P., J. R. Bontha, G. R. Golcar, R. L. Myers, K. G. Rappe, and D. R. Rector, "Bench-Scale Enhanced Sludge Washing and Gravity Settling of Hanford Tank S-107 Sludge," 1998, PNNL-12010, Rev 0, Pacific Northwest National Laboratory, Richland, Washington.
- Brooks, K. P., P. R. Bredt, S. K. Cooley, G. R. Golcar, L. K. Jagoda, K. G. Rappe, and M. W. Urie, "Characterization, Washing, Leaching, and Filtration of AZ-102 Sludge," 2000a, PNWD-3045, Rev 0, Pacific Northwest National Laboratory, Richland, Washington.
- Brooks, K. P., P. R. Bredt, G. R. Golcar, S. A. Hartley, L. K. Jagoda, K. G. Rappe, and M. W. Urie, "Characterization, Washing, Leaching, and Filtration of C-104 Sludge," 2000b, PNWD-3024 Rev 0, Pacific Northwest National Laboratory, Richland, Washington.
- Dash, B., B. C. Tripathy, I. N. Bhattacharya, S. C. Das, C. R. Mishra, and B. K. Mishra, "Precipitation of boehmite in sodium aluminate liquor," *Hydrometallurgy*, 2009, 95, 297-301.
- Fiskum, S. K., E. C. Buck, R. C. Daniel, K. Draper, M. K. Edwards, T. L. Hubler, L. K. Jagoda, E. D. Jenson, G. J. Lumetta, B. K. McNamara, R. A. Peterson, S. I. Sinkov, and L. A. Snow, "Characterization and Leach Testing for REDOX Sludge and S-Saltcake Actual Waste Sample Composites," 2008, PNNL-17368 (WTP-RPT-157), Pacific Northwest National Laboratory, Richland, Washington.
- Lumetta, G. J., B. M. Rapko, J. Liu, D. J. Temer, and R. D. Hunt, "Washing and Caustic Leaching of Hanford Tank Sludge: Results of FY 1998 Studies," 1998, PNNL-12026, Pacific Northwest National Laboratory, Richland, Washington.
- Lumetta, G. J., B. M. Rapko, M. J. Wagner, J. Liu, and Y. L. Chen, "Washing and Caustic Leaching of Hanford Tank Sludges: Results of FY 1996 Studies," 1996, PNNL-11278, Pacific Northwest National Laboratory, Richland, Washington.
- Lumetta, G. J., I. Burgeson, M. J. Wagner, J. Liu, and Y. L. Chen, "Washing and Caustic Leaching of Hanford Tank Sludge: Results of FY1997 Studies," 1997, PNNL-11636, Rev 1, Pacific Northwest National Laboratory, Richland, Washington.
- Lumetta, G. J., K. J. Carson, L. P. Darnell, L. R. Greenwood, F. V. Hoopes, R. L. Sell, S. I. Sinkov, C. Z. Soderquist, M. W. Urie, and J. J. Wagner, "Caustic Leaching of Hanford Tank S-110 Sludge," 2001, PNNL-13702 Rev 0, Pacific Northwest National Laboratory, Richland, Washington.
- Music, S., D. Dragcevic, S. Popovic, and N. Vdovic, "Microstructural Properties of Boehmite Formed Under Hydrothermal Conditions," *Materials Science and Engineering B*, 1998, 52, 2-3, 145-153.

Packter, A., "Studies on recrystallised aluminum mono-hydroxide precipitates. Kinetics of dissolution by sodium hydroxide solutions," *Colloid and Polymer Science*, 1976, 254, 1024-1029.

Palmer, D. A., P. Bénézeth, and D. J. Wesolowski, "Experimental Studies of the Solubilities of Aluminum Oxy-Hydroxy Phases to 300°C," 2000, Oak Ridge National Laboratory, Oak Ridge, Tennessee.

Palmer, D.A., P. Bénézeth, and D. J. Wesolowski, "Aqueous high-temperature solubility studies. I. The solubility of boehmite as functions of ionic strength (to 5 molal, NaCl), temperature (100–290°C), and pH as determined by in situ measurements," *Geochimica et Cosmochimica Acta*, 2001, 65, 13, 2081–2095.

Panias, D., "Role of boehmite/solution interface in boehmite precipitation from supersaturated sodium aluminate solutions," *Hydrometallurgy*, 2004, 74, 203-212.

Pereira, J. A. M., M. Schwaab, E. Dell'Oro, J. C. Pinto, J. L. F. Monteiro, C. A. Henriques, "The kinetics of gibbsite dissolution in NaOH," *Hydrometallurgy*, 2009, 96, 6-13.

Poirier, M. R., P. Burket, and J. L. Siler, "Filtration, Washing, and Leaching of a Hanford AY-102/C-106 Sample," 2003, WSRC-TR-2003-00240, Rev. 0, Westinghouse Savannah River Company, Aiken, South Carolina.

Rapko, B. M., G. J. Lumetta, and M. J. Wagner, "Washing and Caustic Leaching of Hanford Tank Sludges: Results of FY1995 Studies," 1995, PNL-10712, Rev 0, Pacific Northwest National Laboratory, Richland, Washington.

Russell, R. L., R. A. Peterson, H. D. Smith, D. E. Rinehart, P. M. Aker, and E. C. Buck, "Development and Characterization of Boehmite Component Simulant," 2009, PNNL-18176, Rev 0, Pacific Northwest National Laboratory, Richland, Washington.

Skoufadis, C., D. Panias, and I. Paspaliaris, "Kinetics of boehmite precipitation from supersaturated sodium aluminate solutions," *Hydrometallurgy*, 2003, 68, 57-68.

Temer, D. J., and R. Villarreal, "Sludge Washing and Alkaline Leaching Tests on Actual Hanford Tank Sludge: FY1997 Results," 1997, LAUR 97-2889, Rev 0, Los Alamos National Laboratory, Los Alamos, New Mexico.

Temer, D. J., and R. Villarreal, "Sludge Washing and Alkaline Leaching Tests on Actual Hanford Tank Sludge: A Status Report," 1995, LAUR 95-2070 Rev 0, Los Alamos National Laboratory, Los Alamos, New Mexico.

Temer, D. J., and R. Villarreal, "Sludge Washing and Alkaline Leaching Tests on Actual Hanford Tank Sludge: FY1996 Results," 1996, LAUR 96-2839, Rev 0, Los Alamos National Laboratory, Los Alamos, New Mexico.

Willingham, C. E., "Thermophysical Properties of Hanford High-Level Tank Wastes—A Preliminary Survey of Recent Data," 1994, PNL-9419, Rev 0, Pacific Northwest National Laboratory, Richland, Washington.

Appendix B

SOW for Chromium Hydroxide Preparation

Appendix B: SOW for Chromium Hydroxide Preparation

STATEMENT OF WORK

Pilot Scale Filtration Simulant Components – Chromium Oxyhydroxide,
CrOOH, and Chromium Hydroxide,
Cr(OH)₃
July 23, 2007

Introduction

Pacific Northwest National Laboratory (PNNL) is purchasing the components needed to make a non-radioactive filtration simulant. The components include several minerals and chemicals as well as made to order compounds, solutions and slurries. These compounds, solutions and slurries include a supernate, an amorphous Na-Al-Si slurry, an iron-rich sludge slurry and the compounds CrOOH and Cr(OH)₃.

Vendors are participating in a two-phase process; this contract is Phase I in which 1 kg of each compound CrOOH and Cr(OH)₃ is produced, scale-up techniques are determined and the vendor submits an offer for Phase II of the production.

Presently, PNNL is in need of 1 kg of each compound by September 5, 2007 for immediate testing. Waters of hydration may be included in the mass but unbound waters may not. We are relying on vendors with chemical process expertise and experience. The processing of these two chemicals may be challenging. PNNL chemists have produced the compounds under laboratory conditions and their process techniques have been provided below as an aid. Note that these recipes have only been used to generate relatively small amounts of material needed for laboratory testing. If used, the vendor will need to scale up these procedures. The vendor is allowed to make modifications to these recipes or use alternative methods as long as the specifications are met (specifications are provided below).

Once PNNL receives the compounds they will be tested to determine if the product will be useful for our process. Following the testing, a down selection will be made for a vendor to produce 70 kg of each compound. As part of Phase I, the vendor is expected to determine how to process this material to make 70 kg of each material. The vendor will also supply a detailed description of production procedure used, a list of chemicals used including major impurities, and evidence that the specifications have been met. The vendor is expected to provide a quote of the cost for producing the 70 kg batches.

Preparation of CrOOH

Four grams (about 0.01 mmol) of reagent grade Cr(NO₃)₃*9H₂O is placed in 84-mL of water in a Teflon beaker with a Teflon magnetic stirring bar with a graphite bottom suitable for heating on a hot

plate. Sixteen-mL of 19 M NaOH is added to the well-stirred solution. The solution initially forms a precipitate, which then redissolves as more base is added. The mixture is stirred and heated to about 90°C on the magnetic stirrer/hot plate. When the temperature reaches about 80°C, a precipitate appears. The system is then heated at about 90°C for 2 hours.

The system is allowed to cool overnight and centrifuged. The supernatant is removed by decanting. The residual solids are well mixed with a 100-200-mL of DI water and the centrifuge/decanting cycle repeated for a total of 4 contacts with DI water. The residual solids are then dried under vacuum at ca. 80°C for about 72 hrs to yield about 1.04 grams of green solid (1.03 g expected).

The green solid is then ground initially with a mortar and pestle followed by 30 minutes in a ball mill "jitterbug" apparatus. After ball milling for 30 minutes, a particle size of about 10 microns is obtained. The final product should be sieved through a 30-micron mesh sieve to remove large particles. The number of waters (1.0) is determined by thermal gravimetric analysis in air to 600°C. This reaction has been repeated several times with [Cr] initially ranging from 0.1 to 0.25 M at various total reaction volumes.

Specifications:

Quantity: 1 kg dry basis (waters of hydration may be included in mass). Note: unbound water content should be determined either by drying at 105°C for 24 hours or by thermal gravimetric analysis.

Particle size: <30 microns.

Purity: > 99% (based on metals content).

Waters of hydration: 1.0 ±0.1 (as determined by thermal gravimetric analysis in air to 600°C).

Preparation of Chromium(III) Hydroxide

The following two methods have been used to produce Cr(III) hydroxide:

Method 1. Precipitation from Ammonium Hydroxide

CrCl₃*6H₂O (35.636 g; 0.134 mole) is dissolved in 75-mL of deionized (DI) water. The resulting solution is filtered through a 0.45-µm nylon membrane, then it is slowly added (over a period of ~10 min) to 150-mL of 4.9 M NH₄OH (prepared by mixing 50-mL of concentrated NH₄OH solution with 100-mL DI water) with stirring. After stirring for ~0.5 h, the chromium (III) hydroxide precipitate is filtered using a 0.45-µm PES vacuum filter unit. The filtered solid is transferred to a beaker and washed with 200-mL of DI water and filtered again through the PES filter. The washing step is repeated, except that the final filtration is performed using a 0.45-µm nylon membrane. The wet chromium (III) hydroxide filter cake is transferred to a watch glass and dried *in vacuo* over Drierite; the solid is occasionally broken up with a spatula to facilitate drying. (The final dry weight was 18.3 g of Cr(OH)₃*xH₂O.) The product was size reduced in a ball mill and should be sieved through a 30 micron mesh to remove large particles. The waters of hydration are determined by firing a measured amount of the product to Cr₂O₃ in a muffle furnace at 500°C. The product is formulated as Cr(OH)₃*2.4H₂O (18.3 g; 0.125 mole) and the product yield was 93%. (Note: Some

Cr remained in the original NH_4OH solution as evidenced by the deep purple color of the filtrate generated when the chromium hydroxide product was filtered. If allowed to stand, a secondary product precipitates from this solution.)

Method 2. Precipitation with Sodium Hydroxide

$\text{CrCl}_3 \cdot 6\text{H}_2\text{O}$ (4.933 g; 0.019 mole) is dissolved in 20-mL of deionized (DI) water. Sodium hydroxide solution (3.251 M, 17.5-mL, 0.057 mole) is added drop wise with stirring. After stirring for 45 min, the chromium(III) hydroxide precipitate is filtered using a 0.45- μm nylon vacuum filter unit. The filtered solid is transferred to a beaker and washed with 20-mL of DI water and filtered again through the nylon filter. The washing step is repeated and the filter containing the wet chromium(III) hydroxide is placed in a vacuum desiccator over Drierite. When the solid is mostly dried, it is transferred to a watch glass, broken up with a spatula, and further dried *in vacuo*. The final product was size reduced in a ball mill and should be sieved through 30 micron mesh to remove larger particles. (In this case, the waters of hydration were not determined. The final dry weight was 2.2 g of $\text{Cr}(\text{OH})_3 \cdot x\text{H}_2\text{O}$.)

Specifications:

Quantity: 1 kg dry basis (waters of hydration may be included in mass). Note: unbound water content should be determined either by drying at 105°C for 24 hours or by thermal gravimetric analysis.

Particle size: <30 microns.

Purity: > 99% (based on metals content).

Waters of hydration: 2.4 ± 0.2 (as determined by thermal gravimetric analysis in air to 600°C).

Appendix C

**Make Up of PEP Simulant and Component Composition and
a Recipe for CrOOH Slurry (from WPT-RPT-201)**

Appendix C: Make Up of PEP Simulant and Component Composition and a Recipe for CrOOH Slurry (from WPT-RPT-201)

C.1 Tables Giving PEP Simulant Recipes

Table C.1. Initial PEP Blended Simulant Components (Target of 45 kg of Simulant)

	Ingredients	Preparation
1	Weigh out 31700 g of supernate (pre-shimmed to correct Na concentration).	Appendix A.2
2	Add 7910 g of 5 M NaOH with mixing.	Commercially available laboratory grade
3	Add 779 g gibbsite with mixing.	Commercially available (Almatis C333)
4	Add 779 g boehmite with mixing.	Commercially available (APYRAL AOH 20)
5	Add 91.4 g Cr oxy-hydroxide slurry with mixing.	Purchased from Noah Chemical
6	Add 225 g sodium oxalate with mixing.	Commercially available laboratory grade
7	Add 3560g iron rich sludge simulant with mixing.	Appendix A.3
8	Add another 638 g of 5M NaOH with mixing.	Commercially available
9	Actively mix for 1 hour.	

Table C.2. PEP Blended Simulant Components with CrOOH Slurry Added Later
(Target of 28.5 kg Simulant)

	Ingredients	Preparation
1	Weigh out 24800 g of supernate (pre-shimmed to correct Na concentration).	Appendix A.2
2	Add 458 g gibbsite with mixing.	Commercially available (Almatis C333)
3	Add 458 g boehmite with mixing.	Commercially available (APYRAL AOH 20)
4	Add 131 g sodium oxalate with mixing.	Commercially available laboratory grade
5	Add 2150 g iron rich sludge simulant with mixing.	Appendix A.3
6	Add another 379 g of 5 M NaOH with mixing.	Commercially available laboratory grade
7	Actively mix for 1 hour.	

C.2. Preparation of Precipitated Fe-Rich Sludge Solids

This recipe details the steps to make Precipitated Fe-Rich Sludge Solids. The general steps involved are to dissolve metal nitrates, neutralize these nitrates to form the metal hydroxides, add trim chemicals (phosphate, oxalate, carbonate), then wash the solids with the Simple Supernate for Washing and then with the Supernate. **Note that the supernate recipes and sludge washing steps are not included.**

Note: $\leq \pm 0.5\%$ is sufficient accuracy on masses.

The following preparation should be carried out in a plastic or stainless steel vessel. **No glass shall be used.** All additions are based on mass.

Note: The target weight of precipitated solids is ~ 60 g.

Tare weight of 2-L vessel: _____

1- Add to the 2-L vessel:

	Target Mass (g)	Actual Mass (g)
Deionized Water	~ 300	

C.2.1 Manganese Dioxide Production

2- Add to the 2-L vessel:

Compounds	Formula	Target Mass (g)	Actual Mass (g)
Potassium Permanganate	KMnO_4	4.37 ± 0.022	

Compound should completely dissolve.

3- Add to the 2-L vessel:

Compounds	Formula	Target Mass (g)	Actual Mass (g)
Manganous Nitrate Solution	$\text{Mn}(\text{NO}_3)_2$, 50 Wt% solution	14.85 ± 0.074	

Mix vigorously for ~ 15 minutes. It will produce fine black solids which will remain suspended while being agitated.

C.2.2 Preparation of Metal Hydroxides

4 Add to the 2-L vessel the following transition and other metals compounds with mixing to make sure of complete dissolution (order not of addition not believed important):

Compounds	Formula	Target Mass (g)	Actual Mass (g)
Barium Nitrate	Ba(NO ₃) ₂	0.213±0.001	
Calcium Nitrate	Ca(NO ₃) ₂ ·4H ₂ O	2.425±0.012	
Cadmium Nitrate	Cd(NO ₃) ₂	0.06±0.0003	
Cerium Nitrate	Ce(NO ₃) ₃ ·6H ₂ O	0.65±0.003	
Copper Nitrate	Cu(NO ₃) ₂ ·3H ₂ O	0.157±0.0008	
Ferric Nitrate	Fe(NO ₃) ₃ ·9H ₂ O	128.1±0.64	
Lanthanum Nitrate	La(NO ₃) ₃ ·6H ₂ O	0.482±0.002	
Lead Nitrate	Pb(NO ₃) ₂	1.295±0.006	
Magnesium Nitrate	Mg(NO ₃) ₂ ·6H ₂ O	1.72±0.009	
Neodymium Nitrate	Nd(NO ₃) ₃ ·6H ₂ O	1.32±0.007	
Nickel Nitrate	Ni(NO ₃) ₂ ·6H ₂ O	2.87±0.014	
Praseodymium Nitrate	Pr(NO ₃) ₃ ·xH ₂ O x~6	0.33±0.002	
Ruthenium Trichloride	RuCl ₃	0.11±0.0005	
Silver Nitrate	AgNO ₃	0.486±0.002	
Strontium Nitrate	Sr(NO ₃) ₂	0.347±0.002	
Yttrium Nitrate	Y(NO ₃) ₃ ·6H ₂ O	0.14±0.0007	
Zinc Nitrate	Zn(NO ₃) ₂ ·6H ₂ O	0.169±0.0008	
Zirconyl Nitrate	ZrO(NO ₃) ₂ ·xH ₂ O x~6	1.73±0.009	
Mercuric Nitrate	Hg(NO ₃) ₂	0.052±0.0003	

- 5 Mix vigorously to completely dissolve everything except the fine black solids of MnO₂. A little DIW may be added if necessary for complete dissolution to occur.

DIW water added: _____

C.2.3 Neutralization of Nitrate Solution

- 6 Standardize a pH electrode with pH 4, 7 and 10 buffers.

pH 4 buffer:

Manufacturer: _____ Lot#: _____ Exp Date: _____

pH 7 buffer:

Manufacturer: _____ Lot#: _____ Exp Date: _____

pH 10 buffer:

Manufacturer: _____ Lot#: _____ Exp Date: _____

- 7 Place the pH electrode in the precipitation vessel with the metal nitrates and measure the pH.

pH: _____ Note: pH should be <1.

With the nitrate solution agitating, slowly add 8 M NaOH, until the pH reaches 10 to 11. Estimated amount of 8M NaOH needed is 190 g.

8 Measure the pH.

pH: _____

9 Continue mixing for 1 hour and then recheck pH.

pH: _____

10 Add additional 8 M NaOH to return the pH to 10 if it is lower.

Total 8M NaOH added: _____

Final pH: _____

C.2.4 Addition of Additional Reagents

11 Add to the 2-L vessel:

Compounds	Formula	Target Mass (g)	Actual Mass (g)
Calcium Fluoride	CaF ₂	0.205±0.001	
Sodium Phosphate	Na ₃ PO ₄ ·12H ₂ O	5.05±0.03	

12 Combine the following in a separate 250-mL container while stirring:

Compound	Formula	Target Mass (g)	Actual Mass (g)
Water (deionized)		~100	
Sodium Oxalate	Na ₂ C ₂ O ₄	6.7±0.03	

Add this sodium oxalate solution to the 2-L vessel while stirring.

13 Combine the following in a separate 250-mL container while stirring:

Compound	Formula	Target Mass (g)	Actual Mass (g)
Water (deionized)		~100	
Sodium Carbonate	Na ₂ CO ₃	9.50±0.05	

Add this sodium carbonate solution to the 2-L vessel with stirring. Approximate volume at this point should be about 0.9 L.

14 Mix (vigorously) the slurry to ensure good mixing. Mix the slurry for at least 1 hour.

C.3 APYRAL Boehmite Product Description

The mineral powder described below is added to the actively mixing slurry in the amount specified in the recipe.

Provisional Product Information

APYRAL AOH 20, APYRAL AOH 20Y, APYRAL AOH 60

Mineral flame retardants for

- Wire and cable industry
- Electronic industry
- Public Transport

APYRAL®

Typical Analysis		Apyral AOH 20	Apyral AOH 20Y	Apyral AOH 60
AlOOH-Content	[%]	99	99	99
Moisture	[%]	0.2	0.2	0.2
Loss on Ignition	[%]	17	17	17
Particle Size				
Laser Diffraction	D10 [µm]	1.5	0.8	0.4
	D50 [µm]	9	6.5	0.8
	D90 [µm]	20	16	1.6
Sieve Analysis				
> 45 µm	[%]	0.2	0.2	0.02
Specific Surface Area				
BET	[m²/g]	2.4	3	6
Bulk Density				
	[kg/m³]	600	550	400
Oil/Absorption				
	[ml/100g]	35	23	28
Whiteness				
Elrepho 457 nm	[%]	91	92	98
Specific Conductivity				
	[µS/cm]	120	100	60
Refractive Index				
		1.62	1.62	1.62
Mohs Hardness				
		3	3	3
Density				
	[g/cm³]	3.0	3.0	3.0

Produktvorteile / Product properties

- High temperature stability up to 320 °C for high temperature applications
- Various particle size distributions for different applications
- Low sedimentation and good viscosity performance in resins
- Good char promoter

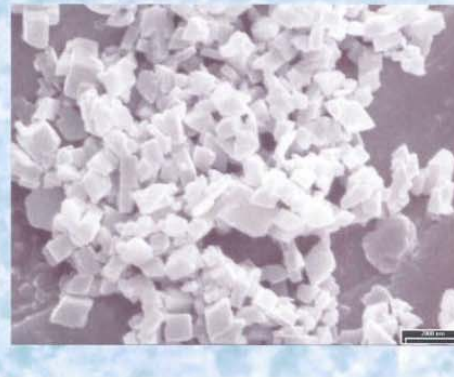

All this Data are provisional and only for information of the user. They do not describe legally binding properties. It remains the responsibility of the users to test the suitability of the products for the application.

C.4 Gibbsite Product Description

The mineral powder described below is added to the actively mixing slurry in the amount specified in the recipe.



Global Product Data

Alumina Trihydroxides Exceptionally Pure White Hydrates

Product Information

Almatris white hydrated alumina is aluminum trihydroxide, $Al(OH)_3$, that is produced through special processing of alumina-bearing feedstocks and stringent process control systems. The result is an aluminum trihydroxide of exceptional purity and whiteness. Although aluminum trihydroxide is a dry powder, it contains a high proportion, approximately 35 percent by weight, of chemically combined water. The hydrate is a nonabrasive, low-density material with a Mohs hardness index of 2.5 - 3.5 and a specific gravity of 2.42. White hydrates are used primarily in applications where color and the absence of impurities are critical. They are halogen-free making them excellent nontoxic flame retardant/smoke suppressant fillers for plastic compounds.

Product Description

Almatris precipitates a highly pure gibbsite phase of alpha alumina trihydrate. The Almatris proprietary white stream process is designed, through chemical and recrystallization processes, to achieve near 100 percent photovolt brightness and relatively uniform particles.

C-33 and C-31C (coarse)

The precipitation process is controlled to produce two median particle sizes, Grades C-33 (50 microns) and C-31C (85 microns). Both grades have free-flowing properties.

C-333 Ground White Hydrates

A fine size grade is produced by grinding the precipitated grade to form C-333 (7 microns).

Applications

Grades C-33 and C-31C hydrates are used in the manufacture of glass, chemicals, catalysts, vitreous enamels and ceramic whitewares, and as additives in high quality pigments. These products are also used as additives and fillers in polymer systems such as electrical wire insulation and high quality cultured onyx and solid countertop surfacing material. Aluminum trihydroxides are preferred because of their good arc and track resistance, aesthetic properties, reinforcing characteristics, and performance as nontoxic smoke suppressants and flame retardants.

C-333 is a ground version of the precipitated grade. It is used in polymer formulations, toothpastes, adhesives, coatings, paper, cosmetics, waxes, and polishes.

Think alumina, think Almatris.

GP-SH/024/R05/1207/MSDS 839



Alumina Trihydroxides

Exceptionally Pure White Hydrates

Product	Aluminum Trihydroxides			Test Methods
	C-33	C-31C	C-333	
Chemical Composition (%)				
Al(OH) ₃ (min)	99.6	99.6	99.6	Difference
SiO ₂	0.003	0.003	0.003	DC Arc Optical Emission Spectrometry
Fe ₂ O ₃	0.009	0.009	0.009	
Na ₂ O (total)	0.20	0.26	0.17	
Na ₂ O (soluble)	0.008	0.008	0.026	Flame Emission Photometry
Moisture	0.08	0.08	0.26	Microwave
Physical Properties				
Loose bulk density (g/cm ³)	1.07	1.15	0.76	Modified ASTM B212-89
Packed bulk density (g/cm ³)	1.3	1.3	1.15	Modified ASTM B527-85
Refractive index	1.57	1.57	1.57	
Mohs hardness	2.5-3.5	2.5-3.5	2.5-3.5	
Density (g/cm ³)	2.42	2.42	2.42	
Surface area (m ² /g)	-	-	3.0	BET
LOI (%)	34.6	34.6	34.6	From 110-1100°C
Color	White	White	White	
Particle Size Distribution				
% on 100 Tyler mesh	0	0	-	
% on 200 Tyler mesh	8	45	0	
% on 325 Tyler mesh	60	90	1	
% through 325 Tyler mesh	40	10	99	Wet Screen
d50 (µ)	50	85	7	Sedigraph 5100 or Microtrac

2003 Data - All data are based upon Almatis standard test methods, and all test methods are available upon request.
Unless stated otherwise values are typical.

C.5 Preparation of Chromium Oxyhydroxide (CrOOH) Slurry

General

The following recipe, which assumes 100% Cr solids yield, will provide 73.2 kg Cr as CrOOH in a nominal 2 M hydroxide slurry. Past characterizations suggest that the UDS is nominally CrOOH—H₂O.

Recipe

- 1) Completely dissolve 140.8 kg of Cr(NO₃)₃·9H₂O in 1410 kg DIW with stirring. The DIW to Cr(NO₃)₃·9H₂O mass ratio is 10:1 is critical. Use a saturated Cr(NO₃)₃·9H₂O solution (77-wt% Cr(NO₃)₃·9H₂O) and dilute rather than beginning with a solid reagent to make certain that all the chromium is in solution.
- 2) Slowly add 203 kg of NaOH in the form of a 0.76 g NaOH/g DIW solution (estimated 15.8 M NaOH) with continued mixing of the solution while maintaining the temperature below 60°C.

Note: A precipitate should form during NaOH addition but should redissolve as more caustic is added.

- 3) After all the solids have redissolved, heat the mixture to 90°C within 1 to 2 h, while mixing.

Note: When the temperature reaches about 80°C, a precipitate should appear.

- 4) Maintain temperature at 90°C for 2 hours while mixing.
- 5) Actively cool the slurry slowly to ambient temperature (~19°C) in 8 to 16 hours while mixing. Monitor the temperature during cooling.
- 6) Measure the UDS and the [OH⁻] by titration to its first equivalence point.

Batch Characterization

- 1) Report the measured PSD, UDS, hydroxide, and the common anions' (nitrate, nitrite, chloride, sulfate, phosphate, and oxalate) concentrations typically obtained using IC or an equivalent method and inorganic carbon.
- 2) Measure the metals content using ICP/OES or equivalent method. The elements to be reported include Al, B, Ba, Bi, Ca, Ce, Cr, Fe, K, La, Mg, Mn, Pb, Nd, Ni, P, Sr, S, Si, Sr, Zn, and Zr.

Distribution

No. of
Copies

No. of
Copies

OFFSITE

ONSITE

- | | | |
|---|---|-------|
| 1 | <u>Pacific Northwest National Laboratory</u>
(Authors will be notified electronically) | |
| | W.C. Buchmiller | K6-24 |
| | D.E. Kurath | K3-52 |
| | L.A. Mahoney | K7-15 |
| | R.A. Peterson | P7-22 |
| | B.M. Rapko | P7-25 |
| | D.E. Rinehart | K6-24 |
| | R.L. Russell | K6-24 |
| | Information Release (pdf) | |
| | Project File (1) | K3-52 |
| 4 | <u>Bechtel National, Inc.</u> | |
| | WTP R&T Docs (2) | H4-02 |
| | S.M. Barnes | H4-02 |
| | J.L. Huckaby | H4-02 |



Pacific Northwest
NATIONAL LABORATORY

902 Battelle Boulevard
P.O. Box 999
Richland, WA 99352
1-888-375-PNNL (7665)

www.pnl.gov



U.S. DEPARTMENT OF
ENERGY